



SEPTIEMBRE 2019

VIBRADORA

VIBRADOR OLIVAS SUSAN 007

Motor: Alpina 2 tiempos.

Cilindrada: 52 cc.

Peso: 13,5 kg

Revoluciones de trabajo: 2.400 rpm.

Recorrido barra: 52 mm



0406129

BARA DE ALUMINIO



0406129-85

GOMA PROTECTORA



0406129-1

GANCHO



0406129-2

FUSIBLE



0406129-3

CASQUILLO ALUMINIO



0406129-4

BIELA DOBLE



0406129-5

RETEN



0406129-6

PEINE ELECTRICO

VIBRADOR OLIVAS 12V ELECTRICO
820 PALM. POR MIN.

DETALLE MANDO ELECTRICO



ALARGADERA CON PINZAS



CINTURON DE AMARRE



0406120

BASE + PUAS PEINE
VIBRADOR 0406120



0406120-25

PUA EXTERIOR PEINE
VIBRADOR



0406120-27

PUA INTERIOR PEINE
VIBRADOR



0406120-28

CARCASA
ACONDICIONAMIENTO
PUAS



0406120-38

PEINE ACEITUNA 12-24 V ELECTRICO 900 PALM. POR MIN.



0406119

VARILLA PEINE



0406119-28

MOTOR VAREADOR



0406119-1

PEINE ELECTRICO 12v. 2,3Kg 1500 PALMEADOS/MIN.
MASTIL DE 1,50M A 2,50M.



0406123

CARGADOR SOLAR DE BATERIAS



28017

CARGADOR 10 Amp



CB10

BATERIA GEL 12V 15AH 20HR



FM12170C

MOCHILA TRANSPORTE BATERIA



0406120-10

CABLE VIBRADOR OLIVAS 12V
ELECTRICO



0406120-4

CONECTOR MACHO VAREADOR
0406120



0406120-2

CONECTOR HEMBRA VAREADOR
0406120



0406120-3

CARGADOR BATERIA LITIO



0406120-12

BATERIA LITIO 12V 66Ah



0406120-11

PEINE ELECTRICO - NEUMATICO



PEINE NEUMATICO 180 l/min

A33



ALARGADERA

A62150	1.5m
A62200	2.0m
A62250	2.5m



EMPUÑADURA A73



PEINE NEUMATICO CON MANGO TELESCOPICO 1200 PALMEOS POR MINUTO. CONSUMO DE AIRE 130L/MIN. 2,5Kg. PRESION DE TRABAJO 6-8 BAR.

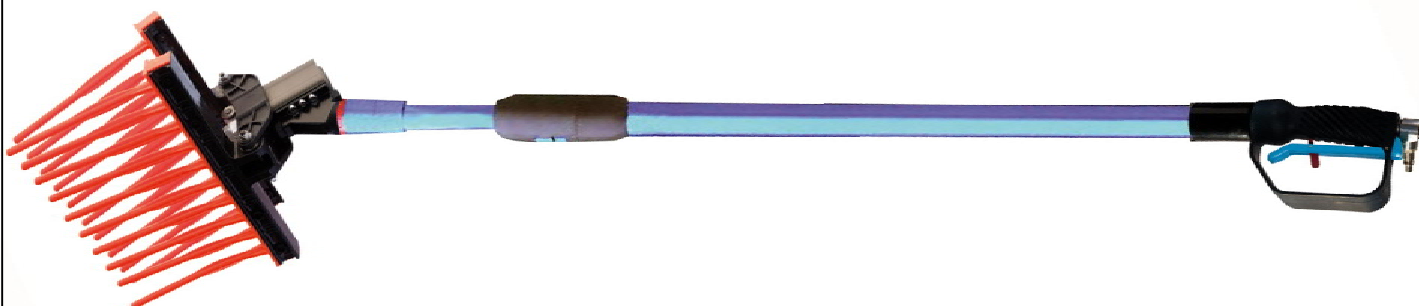

0406121

Estos articulos no son originales, son adaptables a diferentes marcas.

RECAMBIOS PEINE



PEINE SBARAGLIA NEUMATICO 1900 PALMEOS POR MINUTO 675g. 180L/MIN DE CONSUMO DE AIRE.



0406122

KIT PRISIONEROS GOLDKAMM



A1060

KIT JUNTAS PISTON GOLDKAMM



A1040

OSCILADOR GOLDKAMM



A0000

KIT JUNTAS TAPA PISTON GOLDKAMM



A1050

RECAMBIOS PEINE



PISTON EMPUÑADURA



KIT 5 ALETAS SIERRA GOLDEN SEGA



A0000

A1070

ASTA HORQUILLA



ASTA SINGULAR



A1020

A1030

ADAPTADOR PARA TIJERA



EMPUÑADURA COMPLETA



A67

A73

RECOLECTORES

RECOLECTOR ACEITUNA Y FRUTOS SECOS SIN MANGO (LARGO 230 ANCHO 165)

**DIAMETRO DE RECOGIDA DESDE 10mm
VOLUMEN DE RECOGIDA 3.5 lts
CAPACIDAD DE RECOGIDA 20-45 Kg / Hora**



0406135

RECOLECTOR ACEITUNA Y FRUTOS SECOS SIN MANGO (LARGO 283 ANCHO 195)

**DIAMETRO DE RECOGIDA DESDE 20mm
VOLUMEN DE RECOGIDA 6.5 lts
CAPACIDAD DE RECOGIDA 25-60 Kg / Hora**



0406138

TIJERAS PODA

TIJERA DE PODA ELECTRICA 18 V (NO PROFESIONAL) 3,845Kg.



0120006

TIJERAS DE PODA BATERIA PROFESIONAL



TPE02

PODA



TIJERA NEUMÁTICA, 0,650Kg, PRESIÓN DE TRABAJO DE 8 A 10 BAR. 80L/MIN DE CONSUMO DE AIRE. CORTE Ø 32mm



A5P

ACCESORIOS: A67, A62200, 62250, A73,....



MOTOSIERRA NEUMÁTICA

PESO: 1Kg

CONSUMO: 400L / min

BARRA LARGO ALCANCE: OPCIONAL



A23

ACCESORIOS: A62200, 62250, A73,....



COMPRESORES

COMPRESOR AIRE 5.5HP MOTOR OHV160, 244 L/M



4501322

COMPRESOR GASOLINA 5.5 CV.CALDERIN 32 L.354 LM.



4501321

COMPRESOR CON MOTOR DE GASOLINA.(HONDA, SUBARU,OHV200).
DEPOSITO DE AIRE, 17 + 17Lts. 10 Bar. 600 L/Min.

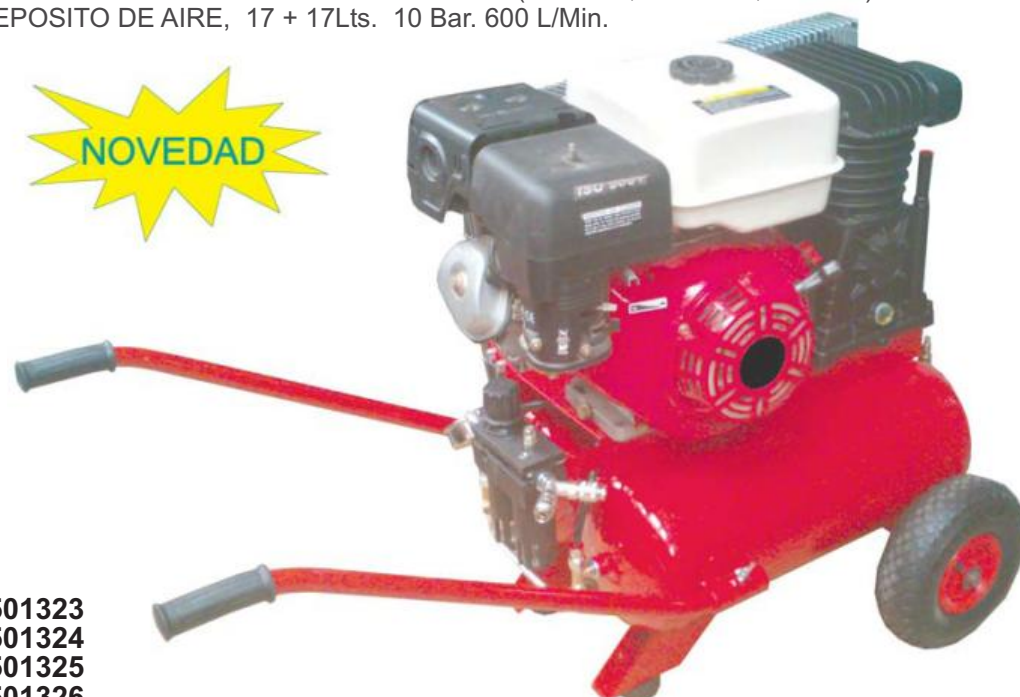

SUBARU

HONDA



4501323
4501324
4501325
4501326

SIN MOTOR.
MOTOR OHV 200, 6.5cv.
MOTOR SUBARU, 6.0cv.
MOTOR HONDA, 5.5cv.

MOTOSIERRA 18cc.



508183

MOTOSIERRA ESPADA PUNTA 12"



0403251

MOTOSIERRA GASOLINA 37cc
ESPADA 350mm 14"



KSMSG1



MOTOSIERRA ESPADA



KM0403450
5016372
5020493
501640

ESPADA 18" 45cc ARRANQUE NORMAL
ESPADA 16" 37,2cc ARRANQUE AUTOMATICO
ESPADA 20" 52cc ARRANQUE AUTOMATICO
ESPADA 16 40cc ARRANQUE FACIL

MOTOSIERRA GASOLINA 72cc
ESPADA 485mm



KM0403720

MOTOSIERRA SEMIPROFESIONAL



REFERENCIA	C.C.	ESPADA
50784014	40	350mm
50784616	46	350mm
50785018	50	350mm
50785418	54	350mm

MOTOSIERRA GASOLINA



REFERENCIA	C.C.	ESPADA
KSMMSG2	43	450mm
KS76117	36	350mm

MOTOSIERRA ELECTRICA 220V, 1600W



REFERENCIA	ESPADA
460240	405mm
460235	350mm

SIERRA DE PODA

SIERRA LARGA DE PODA 240 mm 7"



100105424



SIERRA DE PODA 180 mm 7"



100105418



HOJA DE SIERRA PARA PODA



100015418 180 mm 7"

100015427 210 mm 19"



SIERRA ELECTRICA 500W.

Voltaje	230 V / 50 Hz
Potencia	500 W
R.P.M.	300-3400 rpm
Recorrido	15 mm



KS72891



VOLANTE DE ARRANQUE 45cc



040345021 45cc A100 B12

VOLANTE DE ARRANQUE 25cc

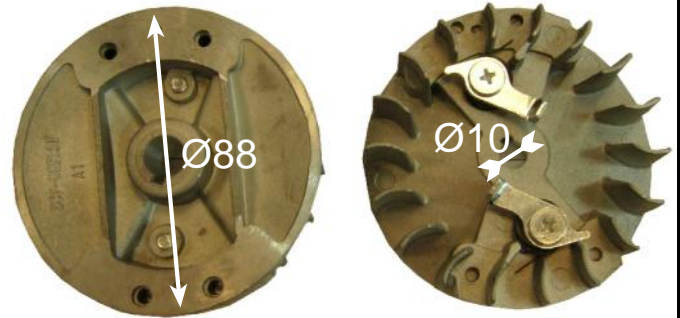

040325124

TAPON DEPOSITO COMBUSTIBLE



040325180 MOTOSIERRA 25cc Ø20
0403450428 MOTOSIERRA 45cc Ø26
0403720-9 MOTOSIERRA 72cc Ø26

TUBO DEPOSITO GASOLINA
MOTOSIERRA 25cc



040325128

BOMBA DE ACEITE 72cc



0403720-12

PIÑON ARRASTRE CADENA



040325148 25cc A57 B13
0403720-13 72cc A75 B16

PIÑON BOMBA ENGRASE MOTOSIERRA 25 CC.

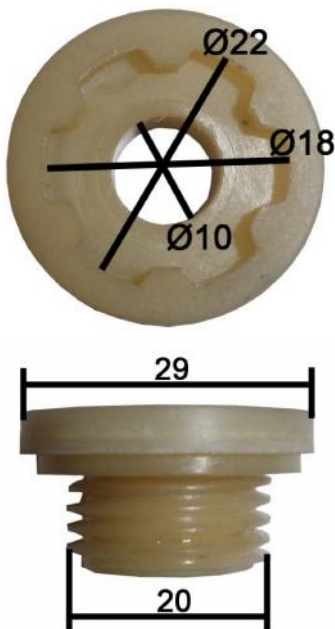

040325141

PIÑON BOMBA ENGRASE MOTOSIERRA 18", 45", 46", 52"

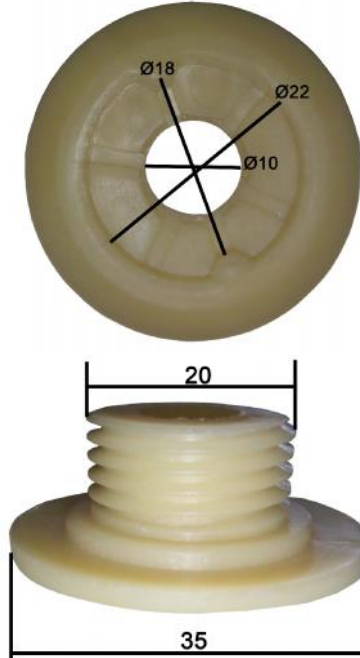

PIÑON ARRASTRE CADENA 45cc



0403450522

RECAMBIOS MOTOSIERRAS

<p>INTERRUPTOR DE ENCENDIDO 25cc</p>  <p>040325198</p>	<p>INTERRUPTOR DE ENCENDIDO 45cc</p>  <p>0403450220</p>	<p>AMORTIGUADOR MOTOSIERRA PODA</p>  <p>0403251-2</p>
<p>INTERRUPTOR ENCENDIDO MOTOSIERRA 72 CC</p>  <p>0403720-2</p>	<p>ASA FRENO FRONTAL 45cc</p>  <p>040345077</p>	
<p>ASA FRENO FRONTAL 25cc</p>  <p>0403251140</p>	<p>ESCAPE 25cc</p>  <p>040325131</p>	
<p>ESCAPE</p>  <p>408520160</p>	<p>ESPADA MOTOSIERRA 18"</p>  <p>04034503</p>	

ESPADA MOTOSIERRA 12"



04B12C

CADENA MOTOSIERRA CARLTON ESPADA
12" 25cc



04083312
04083318
508183CA

25cc 12"
45cc 18"
MTS18

CADENA MOTOSIERRA 72 CC



0403720-7

BLOQUEADOR DE PISTON



268003

YUNQUE REGULABLE PARA ROMPECADENAS



268002

MANGO AFILADOR



268005

LIMAS AFILADOR



268010

REMACHADOR DE CADENA DE BANCO



268001

RECAMBIOS MOTOSIERRAS

ROMPEDOR DE CADENA DE BANCO



268004

AFILADOR DE CADENA MANUAL



268007

AFILADOR CADENA MOTOSIERRA 80 W.4800 RPM.



268008

AFILADOR CADENA MOTOSIERRA 3000 r/min



268009

CABALLETE MOTOSIERRA PROFESIONAL (MOTOSIERRA NO INCLUIDA)



268012

DETALLES



CABALLETE MOTOSIERRA FORESTAL (MOTOSIERRA NO INCLUIDA)



268014

ROLLOS CADENA MOTOSIERRA



ROLLO CADENA PREMIA SM 1/4" 0,50-1,3mm (CARVILL)



5133AS14050



5133BS325050
5133BS325058
5133BS325063
5133BS38043BP
5133BS38050
5133BS38050BP
5133BS38058
5133BS38063

ROLLO CADENA OPTIMA SM 3/8" 0,50-1,3mm
ROLLO CADENA OPTIMA SM 3/8" 0,58-1,5mm
ROLLO CADENA OPTIMA SM 3/8" 0,63-1,6mm
ROLLO CADENA OPTIMA SM 3/8" B/P 0,43-1,1mm
ROLLO CADENA OPTIMA SM 3/8" 0,50-1,3mm
ROLLO CADENA OPTIMA SM 3/8" B/P 0,50-1,3mm
ROLLO CADENA OPTIMA SM 3/8" 0,58-1,5mm
ROLLO CADENA OPTIMA SM 3/8" 0,63-1,6mm

TRITURADORAS

TRITURADORA DE PIENSO



0407521

TRITURADORAS DE RAMAS

Voltaje	230V/50Hz
Potencia	2400W
Revoluciones	2870rpm
Capacidad de corte	Ø 40mm



KS72497

MULTICORTE

KIT MULTICUTTER



NOVEDAD



MTC25
MTC32

25cc
32cc

MOTOR 25 CC CON SIERRA Y ALARGADERA



0408254

MOTOR CON LANZA Y MANILLAR (25 CC)



0408259

ACCESORIO SIERRA (PARA 25 CC)

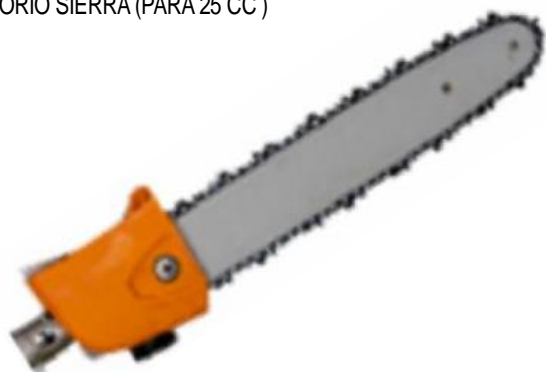

0408258

BRAZO DESBROZADOR COMPLETO (25 CC)



0408257

ACCESORIO CORTASETOS (PARA 25 CC)

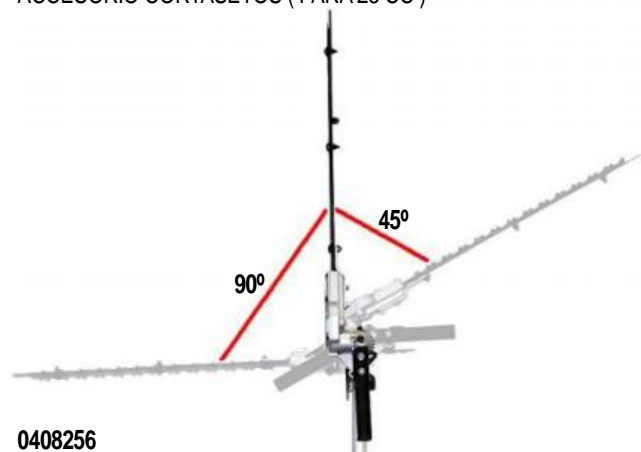

0408256



RECAMBIOS SIERRA MULTICUTTER

<p>PIÑÓN SINFIN ENGRASE SIERRA</p>  <p>0408258-2</p>	<p>BOMBA ENGRASE</p>  <p>0408258-8</p>	<p>GOMA ANTIVIBRATORIA EMBRAGUE</p>  <p>0408258-6</p>
<p>ESPADA STANDAR MULTICORTE 3/8 MTC-25-32</p>  <p>50MTC2533</p>	<p>ENGANCHE RAPIDO ACCESORIO MTC-25</p>  <p>50MTC25/2/93</p>	
<p>GATILLOS</p>  <p>408255B-47 FIG1 BLOQUEO</p> <p>408255B-49 FIG2 ACELERADOR</p>	<p>PIÑÓN CADENA MTC25</p>  <p>0408258-4</p>	
<p>MANDO ACELERADOR COMPLETO MULTICUTTER</p>  <p>408255-44</p>		

DESBROZADORA

DESBROZADORA



DETALLE MOTOR



50D254
50D427

25.4cc
42.7cc

DESBROZADORA

MOTOR: 51.7cc
POTENCIA: 3cv
DEPOSITO: 0.7L
BARRA: Ø28mm
PESO: 8Kg



BC520B

DESBROZADORA 33 CC 4TIEMPOS



50D334T

RECAMBIOS DESBROZADORA

GAFAS PROTECCION POLICARB.
MARCO DE GOMA



450143

MASCARA PROTECCION VISOR PC



268360

MASCARA PROTECCION VISOR
MALLA



268370

CADENA MOTOSIERRA



04083312
04083318

12"
18"

MASCARA PROTECCION MALLA
FORESTAL



268380

MASCARA PROTECCION MALLA



268382

ARNES SIMPLE



04083346

ARNES DOBLE CRUZADO



04083347

ROLLO HILO DESBROZADOR



040810827 GROSOR 2,7mm LARGO 108M
040810830 GROSOR 3 mm LARGO 108M
040810833 GROSOR 3,3 mm LARGO 108M

RECAMBIOS DESBROZADORA



HILO DESBROZADOR



- 26450 GROSOR 2,7mm LARGO 15M
- 26451 GROSOR 3,0mm LARGO 15M
- 26452 GROSOR 3,3mm LARGO 15M
- 040815270 GROSOR 2,7mm LARGO 15M
- 040844271 GROSOR 2,7mm LARGO 44M
- 040844301 GROSOR 3,0mm LARGO 44M
- 26456 GROSOR 3,3mm LARGO 44M

CABEZAL NYLON



04083301

CABEZAL METALICO DES BROZADORA



04083302

DISCO DESBROZADORA 3 PALAS 255 x 1.4



04083303

DISCO DESBROZADORA 4 PALAS 255 X 1.4



04083304

DISCO DESBROZADORA 40 DIENTES 255 X 1.3



04083340

RECAMBIOS DESBROZADORA

GUADAÑA PARA DESBROZADORAS



04083345

PROTECTOR PLASTICO DESBROZADORA
UNIVERSAL PARA TUBOS DE Ø22,24,26,28mm



268372

PROTECTOR METALICO DESBROZADORA
UNIVERSAL PARA TUBOS DE Ø22,24,26,28mm



268374

CABEZAL DESBROZADOR



BROGIO5
BROGIO7

5 ESLABONES
7 ESLABONES

CABEZAL DESBROZADORA METAL.
36 x 110

CUCHILLA PLASTICA DESBROZADORA



272510



RECAMBIO

27252

RECAMBIOS DESBROZADORA



**CABEZAL DOBLE DESBROZADORA
36 x 110**

CUCHILLA PLASTICA DESBROZADORA



RECAMBIO 27252

272620

CAJA TORNILLERIA Y TUERCAS A IZQUIERDAS



10 TUERCAS DE M8x1.25mm
10 TUERCAS DE M10x1.00mm
10 TUERCAS DE M10x1.25mm
10 TUERCAS DE M10x1.50mm
8 TUERCAS DE M12x1.50mm
8 TUERCAS DE M12x1.75mm

10 TORNILLOS DE M10x1.50mm
10 TORNILLOS DE M10x1.25mm
10 TORNILLOS DE M8x1.25mm
8 TORNILLOS DE M7x1.00mm

040819221

TORNILLO IZQ.

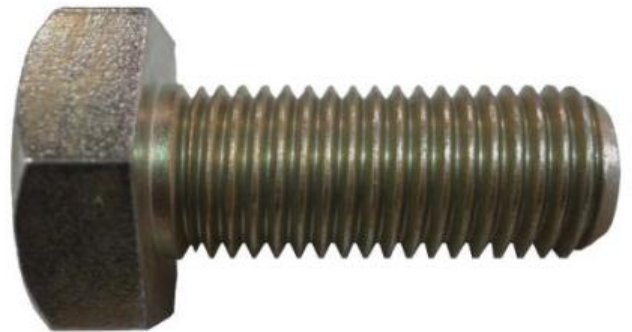

**264740
264750
264760
264770**

**TORNILLO IZQ. 7X1.00
TORNILLO IZQ. 8X1.25
TORNILLO IZQ. 10X1.25
TORNILLO IZQ. 10X1.50**



**264780
264790
264800
264810
264820
264830**

**TUERCA IZQ. 8X1.25
TUERCA IZQ. 10X1
TUERCA IZQ. 10X1.25
TUERCA IZQ. 10X1.50
TUERCA IZQ. 12X1.50
TUERCA IZQ. 12X1.75**

VOLANTE DE ARRANQUE



408520131

JARDIN BATERIA 56V

KIT CORTACESPED 56v. BAT, 4 Ah, CARGA RAPIDA

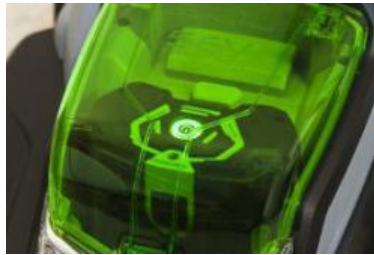

LM2001E

CARGADOR RAPIDO



CH5500E

CARGADOR STANDAR



CH2100E

BATERIA LITIO



BA1120E

4.0Ah

2.0Ah

JARDIN BATERIA 56V

SOPLADOR 56v. (NO INCLUYE BATERIA)



LB4800E

CORTASETOS 56v. (NO INCLUYE BATERIA)



HT2400E

MOTOSIERRA 56v. (NO INCLUYE BATERIA)



CS1400E

DESBROZADORA 56v. (NO INCLUYE BATERIA)



ST1500E

ASPIRADOR - SOPLADOR

SOPLADOR ASPIRADOR PORTATIL 1100W 32CC

ASPIRADOR CON BOLSA



DETALLE TURBINA



PARA SOPLADO



0408004

SOPLADOR

SOPLADOR MOCHILA 2700W 63.3CC

DETALLE ARNES



0410630

MOCHILA DE PULVERIZAR A MOTOR



MOCHILA 20 LITROS MOTOR 25.4CC

ACCESORIOS



0407260

PULVERIZADOR 25 L. MOCHILA MOTOR 25CC



0407262

ATOMIZADOR DE POLVO Y AGUA

26L. 2.130W 42CC



0407420



26L. 2.130W 42CC



0407410

CORTACESPED - SETOS

CORTACESPED



REF.	POTENCIA	MOTOR	ANCHO CORTE	GAMA	TRACCION	BOLSA
CTC42	2,5Kw-3,35 Hp	GASOLINA 119cc	42cm	DOMESTICO	NO	40 L
CTC46	3,5Kw-4,69 Hp	GASOLINA 139cc	46cm	DOMESTICO	SI	60 L
CTC51	5,0Kw-6,75 Hp	GASOLINA 200cc	51cm	DOMESTICO	SI	60 L

MANDO ACELERADOR
CORTACESPED



411203-5

MANDO ACELERADOR
CORTACESPED CON CABLE



411203-6

PARE
CORTACESPED



411203-4

CABLE PARE
CORTACESPED



411203-8

MOTOR HORIZONTAL 99cc EJE Ø22 LARGO44mm



MCTC40



CORTACESPED - SETOS

MOTOR HORIZONTAL 139cc EJE Ø22
LARGO 52mm



MCTC46

MOTOR HORIZONTAL 200cc EJE Ø22 LARGO 60mm



MCTC51

CORTASETOS 22.5CC CUCHILLA SIMPLE 280 MM 750 MM



CTS22

CORTASETOS 25.4CC CUCHILLA 600MM



CTS25

MOTOAZADA

MOTOAZADA KOHLER 6,5 CV 15LD350



924005

MOTOAZADA 5 HP ROJA

Tipo de motor	OHV
Referencia	924001
Tamaño (mm)	1115x585x975
Peso neto/Peso bruto	30/35
Ancho labor (mm)	400-550
Profundidad labor (mm)	100-200
Marchas motor	1
Depósito de aceite transmision	0.6
Modelo motor	OHV160
Cilindrada	160 c.c. 5.5HP
Capacidad depósito	-
Depósito aceite	0.6
Filtro de aire	semi-seco,bañado en aceite



MOTOR HORIZONTAL RECAMBIO MOTOAZADA 5HP



DETALLE CIGÜEÑAL MOTOR



924001-1 MOTOR HORIZONTAL

Estos articulos no son originales, son adaptables a diferentes marcas.

MOTOAZADA

**CHASIS MOTOAZADA 2 VELOC. Y M.ATRAS
A FALTA SOLO MOTOR**



925000



MOTORES ESPECIAL MOTOAZADA



SUBARU.



883ROBIN160LM

HONDA



883HONDA160LM

MOTOAZADA



DETALLE TRANSMISION



Tipo de motor	OHV	HONDA	NOUKI
Referencia	925001	500B3	925002
Tamaño (mm)	1380x650x970	1380x650x970	1380x650x970
Peso neto/Peso bruto	75/90	75/90	75/90
Ancho labor (mm)	600-1000	600-1000	600-1000
Profundidad labor (mm)	150-300	150-300	150-300
Marchas motor	1°,2°,0 -1	1°,2°,0 -1	1°,2°,0 -1
Depósito de aceite transmision	0.95	0.95	0.95
Modelo motor	OHV 200	HONDA GX160	NOUKI
Cilindrada	196 c.c. 6.5HP	160 c.c. 5.5HP	7.0HP
Capacidad depósito	3.6	3.6	3.6
Depósito aceite	0.6	0.6	0.6
Filtro de aire	semi-seco,bañado en aceite	semi-seco,bañado en aceite	semi-seco,bañado en aceite
Ruedas de Transporte	SI 3.50X4	NO	NO

Referencia	925003
Ancho labor (mm)	1300mm
Motor	OHV 210
Potencia	7Hp
Transmision	Engranajes en baño de aceite. Embrague de discos en baño de aceite.
Velocidad	3 delanteras+ 1 trasera
Peso neto/Peso bruto	100Kg

MOTOAZADA

MOTOCULTOR PANZER 9.0 HP RUEDAS 9+ FRESA



92650X

RECAMBIOS MOTOAZADA

MOTOCULTOR CON MOTOR 7HP, CAMBIO DE FUNDICION,



DETALLE TRANSMISION

Tipo de motor	OHV
Referencia	924004
Tamaño (mm)	1390x800x1070
Peso neto/Peso bruto	75/90
Ancho labor (mm)	800-1000
Profundidad labor (mm)	150-300
Marchas motor	1°,2°,0 -1
Depósito de aceite transmision	0.95
Modelo motor	OHV 220
Cilindrada	196 c.c. 7HP
Capacidad depósito	6.5
Depósito aceite	0.6
Filtro de aire	semi-seco,bañado en aceite

JUEGO RAMPAS MAXIMO 680 KG





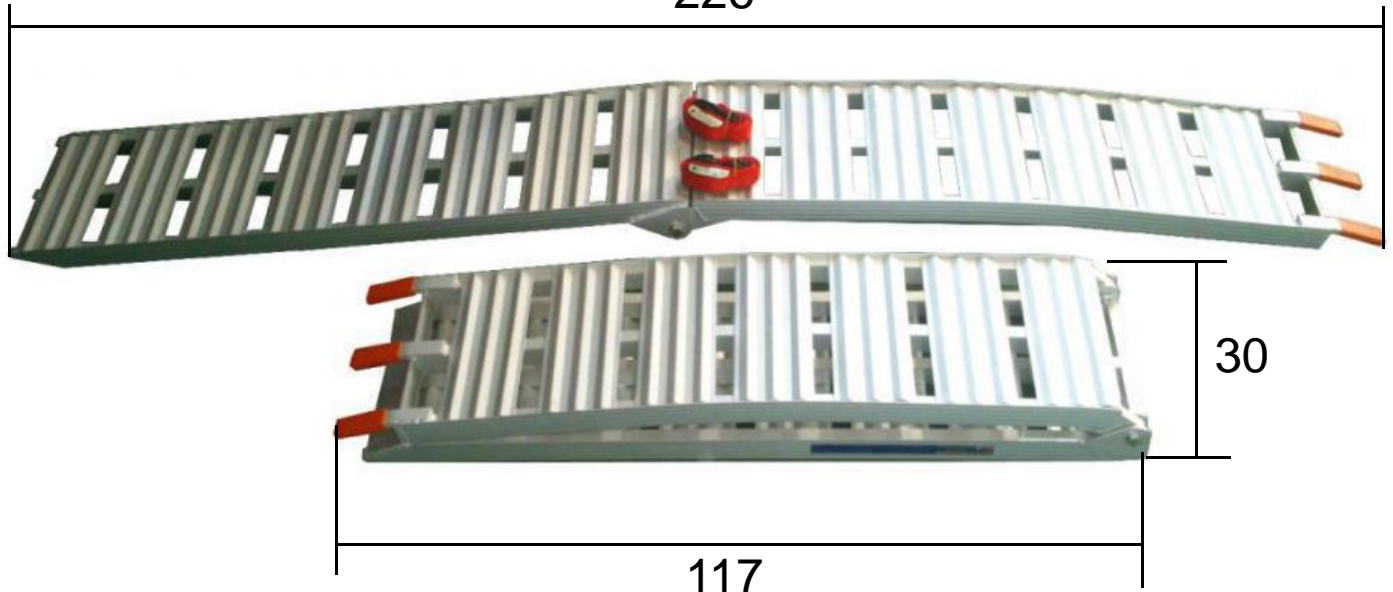





226

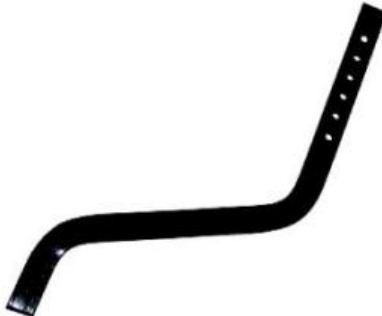

925010

RECAMBIOS MOTOAZADA

<p>MANILLAR COMPLETO</p>  <p>71ZS65026</p>	<p>CUELLO UNION MANILLAR CHASIS</p>  <p>71ZS65027</p>
<p>ALETA EXTERIOR</p>  <p>71ZS65028 (DER) 71ZS65030 (IZQ)</p>	<p>ALETA INTERIOR</p>  <p>71ZS65029</p>
<p>BARRA INFERIOR</p>  <p>71ZS65031</p>	<p>PROTECTOR MOTOR</p>  <p>71ZS65032</p>
<p>TAPA PROTECTORA, CORREA Z</p>  <p>71ZS65033</p>	<p>MEDIDOR DE PROFUNDIDAD</p>  <p>400823</p>
<p>PLACA UNION ALETA</p>  <p>71ZS65035</p>	<p>ARRANQUE COMPLETO MOTOAZADA NOUKI</p>  <p>78011008</p>

RECAMBIOS MOTOAZADA

MUELLE TENSOR, LEVA POLEA
TRANS



71ZS65037

PORTA MEDIDOR PROFUNDIDAD



71ZS65040

PLACA CONEXION POLEA
TRANSMISION



71ZS65038

BULON PORTA MEDIDOR



71ZS65039

MANETA DE EMBRAGUE



925001/1

RECEPTOR BRAZOS



71ZS40010

BARRA MANILLAR

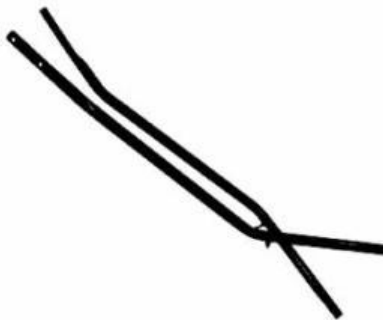

71ZS40001

BASE CIRCULAR MOTOR



71ZS40004

CUELLO UNION, MANILLAR
CHASIS



71ZS40002

ALETA INTERIOR



71ZS40003

RECAMBIOS MOTOAZADA

CAJA ENGRANAJES



71ZS40005

EMPUÑADURA MANILLAR



71ZS40006

MANETA DE EMBRAGUE



71ZS40007



71ZS65043

MOTOAZADA 6.5 HP

CABLE EMBRAGUE



71ZS40009

MOTOAZADA 5HP

CABLE ACELERADOR



71ZS65009

RETEN CAJA CAMBIOS

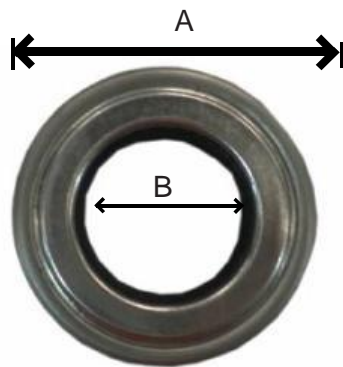

REF.	A	B
71ZS65048	58	25
71ZS65046	47	25

CORREA CAJA ENGRANAJES



71ZS40025
71ZS65021

1WG2
500B-3

PLACA RECTANGULAR

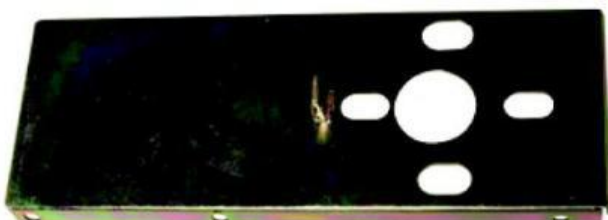

71ZS40019

MUELLE TENSOR CAJA



71ZS40026

RECAMBIOS MOTOAZADA

<p>RUEDA</p>  <p>71ZS40031</p>	<p>RUEDA DELANTER</p>  <p>71ZS65001</p>	
<p>TUERCA DE SEGURIDAD</p>  <p>71ZS65004</p>	<p>PLACA POSICIONAMIENTO CAMBIO</p>  <p>71ZS65003</p>	<p>POLEA</p>  <p>71ZS40027 CAJA DE ENGRANAJES 71ZS40022 SALIDA CIGUEÑAL</p>
<p>RODAMIENTO DEL TENSOR</p>  <p>71ZS65002</p>	<p>RODAMIENTO DEL TENSOR POLEA DOBLE</p>  <p>500B3506</p>	
<p>MEDIDOR DE PROFUNDIDAD</p>  <p>71ZS40028</p>	<p>HORQUILLA RUEDA</p>  <p>71ZS40033</p>	
<p>PORTACUCHILLAS</p>  <p>71ZS40039</p>	<p>CUCHILLA</p>  <p>71ZS40042</p>	

RECAMBIOS MOTOAZADA

ARGOLLA ABRAZADERA



71ZS65012

CUBIERTA MANILLAR PLACA



71ZS65013

POLEA EJE MOTOR

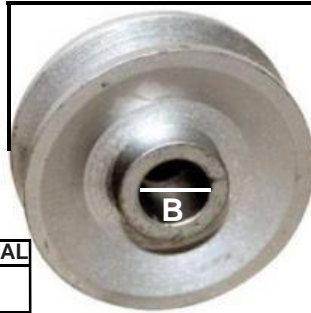

REF.	A	B	CANAL
78000109	80	CONICO 12-18	7
78000110	140	19 ESTRIAS Ø15- Ø13	7

CADENA CAJA DE CAMBIOS



71ZS65014

MANETA EMGRAGUE



71ZS65044

PIN AJUSTE MANILLAR



71ZS65006

EMPUNADURA MANILLAR

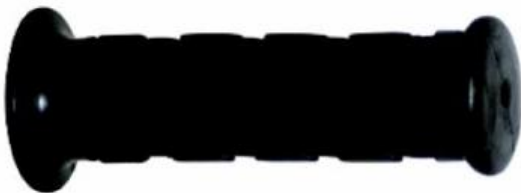

71ZS65010 ESPECIAL MOTOAZADA
60166
60167
60170

Ø22 INT
Ø25 INT
Ø27 INT
Ø30 INT

CUBRE GUIA EJE DE MOTOR



71ZS65018

INTERRUPTOR PARO



71ZS65008

PALANCA DE CAMBIO



71ZS65011

TOPE METALICO CORREA



71ZS65019 SUPERIOR
71ZS65020 INTERIOR

TOPE METALICO POLEA TRANSMISION



71ZS65023

TAPA METALICA GUIA



71ZS65025

CARCASA CAJA ENGRANAJES



925002-4

CAJA ENGRANAJES COMPLETA



925002-5

FILTRO AIRE BAÑO DE ACEITE OHV 160



78001011

FILTRO AIRE BAÑO DE ACEITE OHV 240-270



78001013

FILTRO AIRE BAÑO DE ACEITE OHV 340-390



78001015

PLATO PORTACUCHILLAS



401790

RECAMBIOS MOTOAZADA

CUBIERTA 300-4 4 PR.



401211

CUBIERTA 400-8 4 PR



400260

CUBIERTA (400-10) 2 PR.



401160

CUBIERTA (500-10) 6 PR.



401170

CUBIERTA (500-12) 4 PR



400210

CAMARA 3.50-8 + 4.00-8



403800

CAMARA 3.50-4



403789

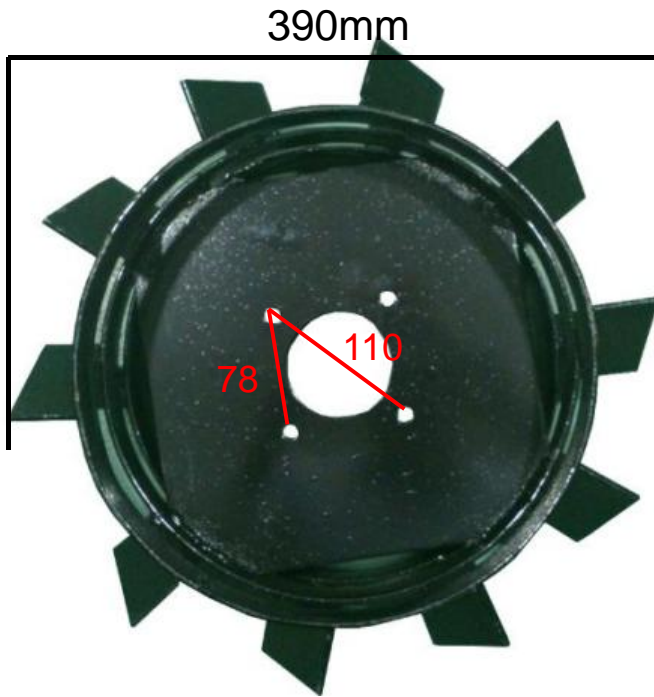

401778 JUEGO RUEDAS METALICA 4.00-8

KIT 2 RUEDAS Y LLANTAS 350-4 MOTOAZADA HEXAGONO 26 mm



401770

RUEDA MOTOAZADA 4.00-8
EXAGONO DE 26mm



401774 RUEDA MOTOAZADA 4.00-8
401780 CONJUNTO BUJES

RECAMBIOS MOTOAZADA



PORTACUCHILLAS EXTERIOR FRESA CON
4 CUCHILLAS



401801

PORTAFRESAS



400840

PORTACUCHILLAS EXTERIOR FRESA CON
8 CUCHILLAS



401802

SOPORTE CAMBIAFRESAS



400842

PORTACUCHILLAS

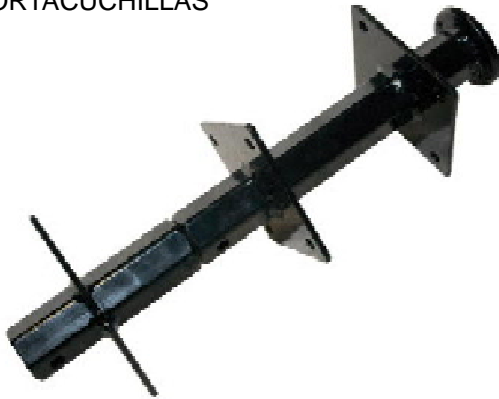

401784

CUCHILLA



401786 (DER)
401785 (IZQ)

RETOVATOR COMPLETO

SE COMPONE DE:
2 EJES Y 24 CUCHILLAS



401800

RECAMBIOS MOTOAZADA

CONJUNTO EJES DESPLAZABLES CON BLOQUEO(JUEGO 2 PIEZAS)



401771

CONJUNTO EJES DESPLAZABLES(JUEGO 2 PIEZAS)



401772

PORTACUCHILLAS EXTERIOR MTZ-900



CONJUNTO BUJES



401782

401780

RECAMBIOS MOTOAZADA

JUEGO RUEDAS METALICAS EJE CILINDRICO Ø25



401776

DIAMETRO DE RUEDA 320mm

SURCADOR

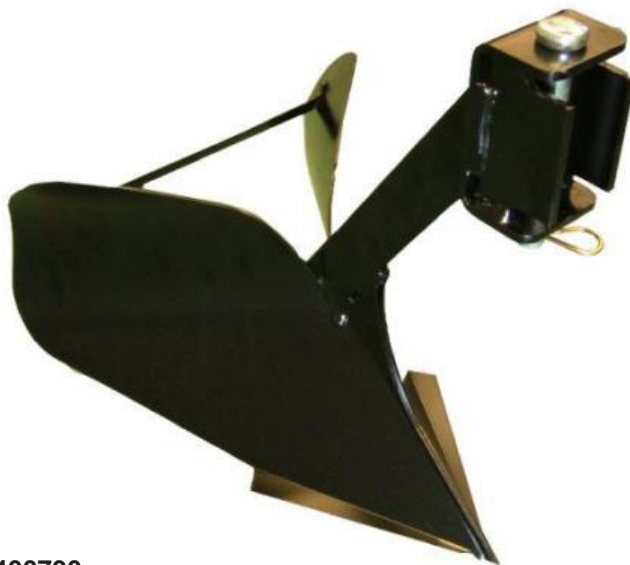

400790

SURCADOR PARA MOTOCULTORES
HONDA 5.5 Y 6.5 HP



400800

SURCADOR GRADUABLE PARA HONDA

ARADO FIJO



400810

ARRANCA PATATAS MOTOAZADA



400820



400830

RECAMBIOS MOTOAZADA

SOPORTE PARA ARADO 400824



400822

KIT CABALLONADORA (EJE 23 MM) ALTO 230 MM

ARADO DESPLAZABLE



400824

VISTA TRASERA

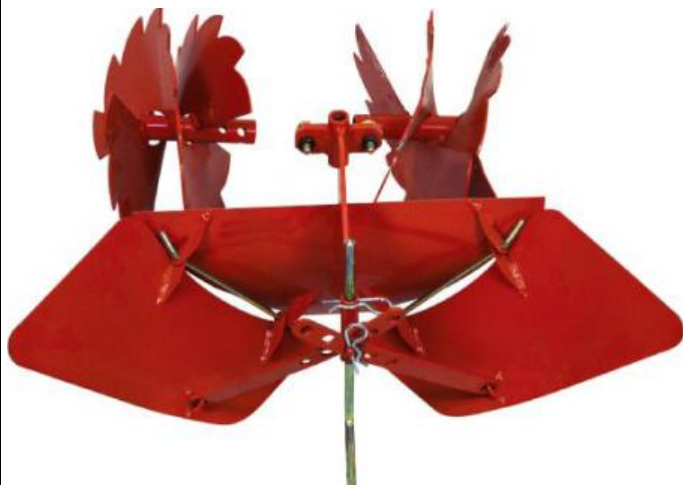

400826

KIT CABALLONADORA (EJE 23 MM) ALTO 300 MM

VISTA DELANTERA



VISTA TRASERA



400828

VISTA DELANTERA



HIDROLIMPIADORAS

HIDROLIMPIADORA 13 CV 250 BAR



3635130D
3635130D1

Motor	OHV 13HP
Arranque	Eléctrico
Presión trabajo	250bar(3600PSI)
Máx. presión	280bar(4000PSI)
Flujo	13.5L/min(3.5GPM)
Peso Bruto	67/64Kg

HIDROLIMPIADORA AGUA FRIA



510565175

TIPO	GASOLINA
POTENCIA	6,5Hp-4,85Kw
PRESION TRABAJO	150Atm
L/MIN.	8,3
GAMA	PROFESIONAL

HIDROLIMPIADORA AGUA FRIA



510513252E

TIPO	GASOLINA
POTENCIA	13Hp-9,70Kw
PRESION TRABAJO	180Atm
L/MIN.	13,2
GAMA	PROFESIONAL

HIDROLIMPIADORAS

HIDROLIMPIADORA AGUA FRIA



TIPO	ELECTRICA
POTENCIA	5,36Hp-4,0Kw/410V
PRESION TRABAJO	160Atm
L/MIN.	7,8
GAMA	PROFESIONAL

51054180

HIDROLIMPIADORA AGUA FRIA

TIPO	ELECTRICA
POTENCIA	10Hp-7,46Kw/410V
PRESION TRABAJO	200Atm
L/MIN.	8,7
GAMA	PROFESIONAL



510575210

HIDROLIMPIADORAS

HIDROLIMPIADORA AGUA FRIA



TIPO	ELECTRICA
POTENCIA	2,41Hp-1,8Kw/230V
PRESION TRABAJO	110Atm
L/MIN.	6
GAMA	BRICOLAJE

5107110P

HIDROLIMPIADORA HOBBY AGUA FRIA



TIPO	ELECTRICA
POTENCIA	3,35Hp-2,5Kw/230V
PRESION TRABAJO	130Atm
L/MIN.	6
GAMA	BRICOLAJE

5107130P

KIT HIDROLIMPIADORA 120 BAR 1900 W.



Presión trabajo	110 bar
Máx. presión de trabajo	200 bar
Caudal	6L/min
Máx. presión de salida agua	4 bar
Capacidad motor	1900 W
Voltaje	230 V 50 Hz
Temp. Máx del agua	50° C
Peso	18 Kg
Dimensiones	83x31x41 cm

450127

BOQUILLA HIDROLIMPIADORA 13HP 250BAR



- 3635066 BLANCA DIFUSOR PRESION MODERADA
- 3635067 AMARILLA DIFUSOR ALTA PRESION ESTRECHA
- 3635068 ROJA DIFUSOR ALTA PRESION PUNTO
- 3635069 NEGRA DIFUSOR PRESION BAJA

HIDROLIMPIADORAS

PISTOLA Y LANZA HIDROLIMP. 13 HP SQ2 250 BAR 920mm
37 L/M



3635064
3635065

solo lanza

KIT BOMBA ALTA PRESION 200 AT.24L



267570

6 METROS DE MANGUERA.



3635070
2021071

HIDROLIMPIADORA 13 HP 250 BAR
HIDROLIMPIADORA 6,5 HP 175 BAR

BOMBA PRESION 170 ATM

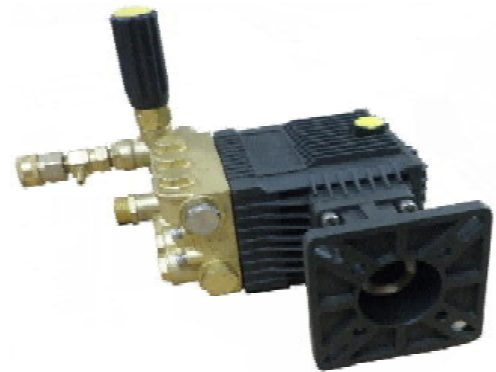

267560

TORNILLO MEDIDOR ACEITE GA-34D



3635GA009

TORNILLOS TAPA LATERAL GA-34D
(4 uds.)



3635GA012

TAPA LATERAL GA-34D



3635GA013

JUNTA TAPA LATERAL GA-34D



3635GA014

TORNILLO FIJO CONECTOR DE TOMA
DE AGUA GA-34D



3635GA059

JUNTA TORNILLO FIJO TOMA AGUA
GA-34D



3635GA061

ARANDELA DEL TORNILLO FIJO
CONECTOR TOMA AGUA GA-34D



3635GA060

JUNTA ANILLO CONDUCTOR



3635GA035

GUARNICION DEL ANILLO
CONDUCTOR



3635GA033



883BA40H

883BA25H

**883BA50H
883BA80H**



883BA100H



**883HONBA50H
883HONBA80H**

MOTOR HONDA			883HONBA50H	883HONBA80H	
MOTOR OHV	883BA25H	883BA40H	883BA50H	883BA80H	883BA100H
Entrada / Salida	1"	38.1 mm / 1.5"	51 mm / 2"	76 mm / 3"	100 mm / 4"
Elevación máxima	22 m	22 m	26 m	30 m	28 m
Capacidad de succión	7 m	7 m	7 m	7 m	8 m
Caudal de trasiego	12 m ³ /h	12 ³ m/h	36 m/h	60 m/h	108 m ³ /h
Tipo motor	2 TIEMPOS	OHV60	OHV120	OHV160	OHV270
Cilindrada		53.2cc	118cc	163cc	270cc
Potencia	1.7 HP	2.5 HP	5.5 HP	6.5 HP	9.0 HP
Máx. potencia de salida		2.0PS/6800rpm	9.0PS/3600rpm		
Sistema de arranque		MANUAL			
Tipo combustible	MEZCLA	GASOLINA			
Capacidad deposito combus.		1.0L	2.5 L	3.6 L	6.0 L
Dimensiones (L x W x H) (mm)		370 x 300 x 430	625 x 445 x 540	515 x 390 x 450	485 x 385 x 380
Peso neto		11 Kg	22 Kg	28 Kg	48 Kg

MOTOBOMBAS DE PRESION



REF.	TIPO SUCCION	TIPO	MOTOR	ENT./SAL	ELEV.MAX.	CAUDAL	CAP. SUCCION
MTB38P	AUTO ASPIRANTE	PRESION	OHV160/5,5Hp	38mm/1,5"	55m	20.000L/h	7m
MTB50P		PRESION	OHV160/5,5Hp	50mm/ 2"	65m	30.000L/h	7m

BOMBA PARA ACIDOS



REF.	TIPO SUCCION	TIPO	MOTOR	ENT./SAL	ELEV.MAX.	CAUDAL	CAP. SUCCION
MTB50AC	AUTO ASPIRANTE	ÁCIDOS	OHV160/5,5Hp	50mm/2"	30m	35000L/h	7m

BOMBA PARA AGUAS SUCIAS



REF.	TIPO SUCCION	TIPO	MOTOR	ENT./SAL	ELEV.MAX.	CAUDAL	CAP. SUCCION
MTB50AS	AUTO ASPIRANTE	AGUAS SUCIAS	OHV200/6,5Hp	80mm/3"	25m	45000L/h	7m

RECAMBIOS MOTOBOMBAS

TAPA BOMBA AGUA



188100002 100H 4"

TAPA BOMBA AGUA



188500002 50H 2"
188800003 80H 3"
188100003 100H 4"

RETEN



188500006 50H 2"/ 80H 3"

ASPA PROPULSORA



188500008 50H 2"
188800012 80H 3"
188100007 100H 4"

GOMA TORICA TURBINA



188500010 50H 2"
188800009 80H 3"
188100009 100H 4"

CUERPO BOMBA



188100010 100H 4"

TAPON DRENAJE



188500005 50H 2"/ 80H 3"/ 100H 4"

JUNTA VALVULA UNIDIRECCIONAL



188100013 100H 4"

RECAMBIOS MOTOBOMBAS

JUNTA COJINETE METALICO



188500005
188100024

50H 2"
80H 3"
100H 4"

JUNTA TOBERA

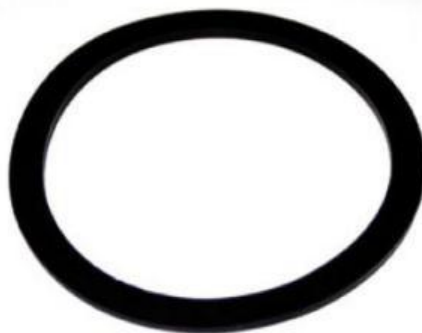

188100016

100H 4"

GUIA DE AGUA



188500009
188800008
188100008

50H 2"
80H 3"
100H 4"

GUIA DE AGUA

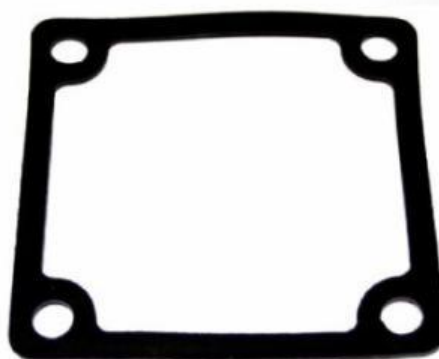

188800013
188100021

80H 3"
100H 4"

JUNTA TAPON DRENAJE



188100012

100H 4"

ABRAZADADERA



188500020
188800017
188100019

50H 2"
80H 3"
100H 4"

JUNTA VALVULA UNIDIRECCIONAL



188500015
188800018
188100015

50H 2"
80H 3"
100H 4"

TOBERA SALIDA



188100020

100H 4"

RECAMBIOS MOTOBOMBAS

FILTRO DEPURADOR



188500019
188800016
188100022

50H 2"
80H 3"
100H 4"

CUERPO BOMBA INTERIOR MTB50AC

5105BAC50-1

CUERPO BOMBA TRASERO EXTERIOR

TUERCA Y TUBO PARA ENGANCHE RAPIDO BOMBA AGUA



788400018
788500018
788800014

40H1.5"
50H 2"
80H 3"

MTB50AC-1

JUEGO REPARACION



188500000
188800000

50H 2"
80H 3"

RECAMBIOS MOTOBOMBAS

ENLACE GUILLEMIN MANGUERA



REF	MEDIDA	ACOPLE HEMBRA
788800028	50MM	788800018
788800015	80MM	788800017
788800016	75MM	788800017

ENLACE GUILLEMIN HEMBRA



788800018 2"
788800017 3"

RACORD CAMLOCK TIPO A



788800023 1"
788800022 1.5"
788800021 2"
788800019 3"

RACORD CAMLOCK TIPO C



REF	MEDIDA	ACOPLE HEMBRA
788800026	25MM	788800023
788800024	40MM	788800022
788800030	50MM	788800021
788800020	75MM	788800019

VALVULAS ADMISION MOTOBOMBAS

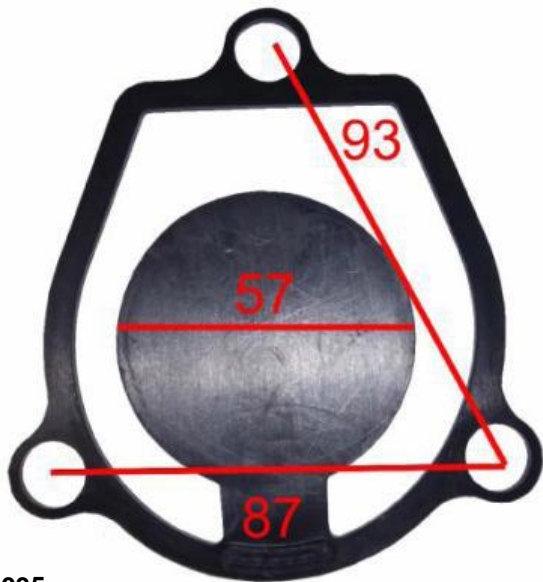

788800035

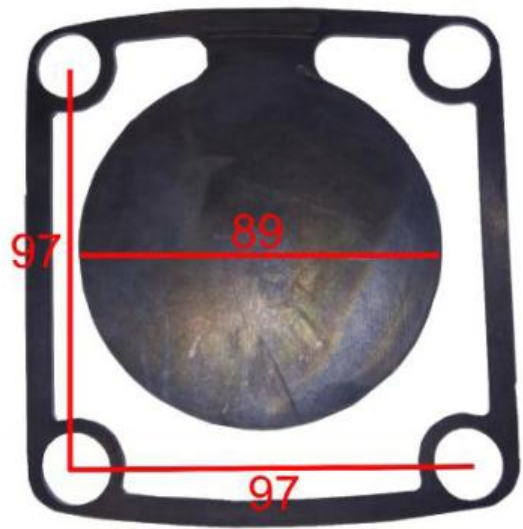

788800036

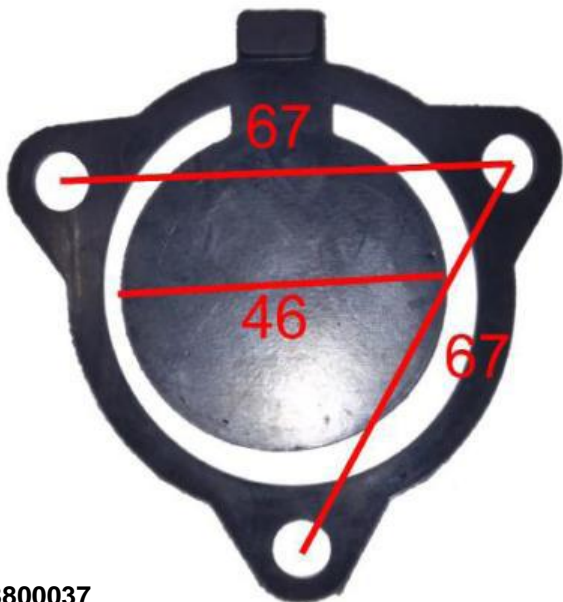

788800037

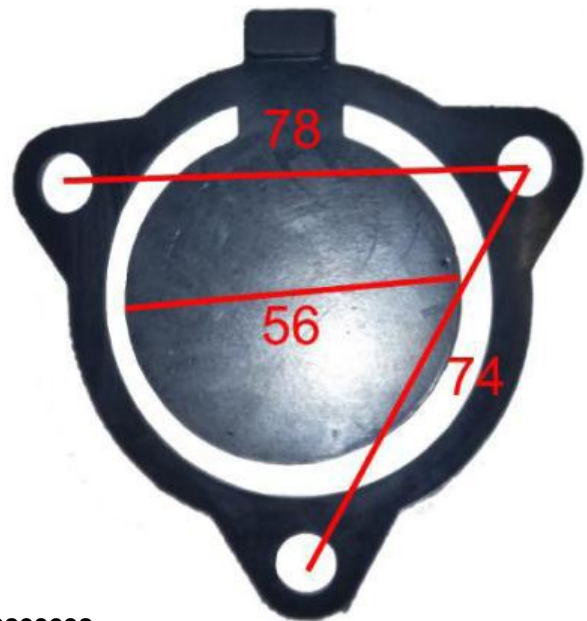

788800038



788800039



788800040

RECAMBIOS MOTOBOMBAS

JUNTA VALVULA ASPIRACION MTB-25

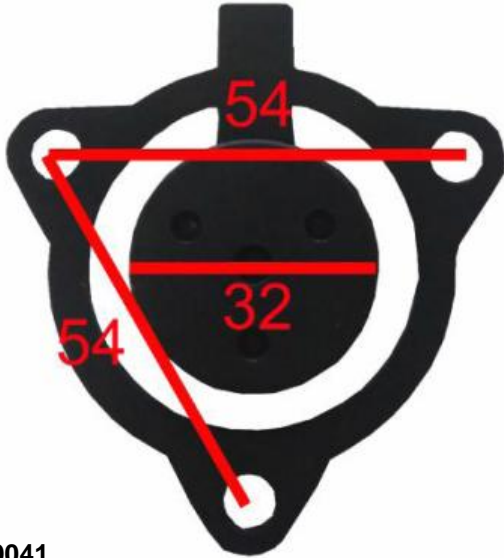

788800041

VALVULA ASPIRACION MTB-50



788800042

JUNTA VALVULA ASPIRACION MTB-38P



788800043

JUNTA DIFUSION MTB-50AC



788800044

JUNTA VALVULA ASPIRACION MTB-80AS



788800045

JUNTA VALVULA ASPIRACION MTB-80

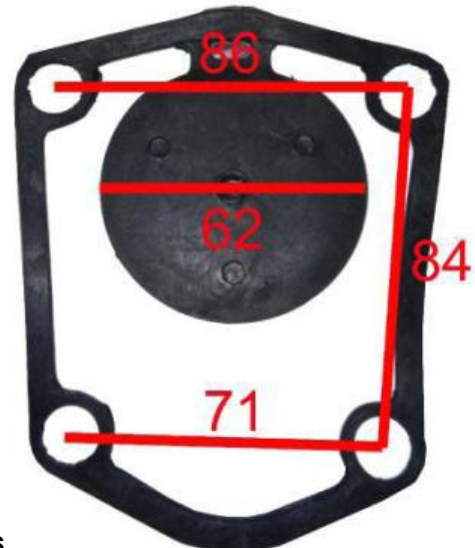

788800046

RECAMBIOS MOTOBOMBAS

JUNTA VALVULA ASPIRACION MTB-50P

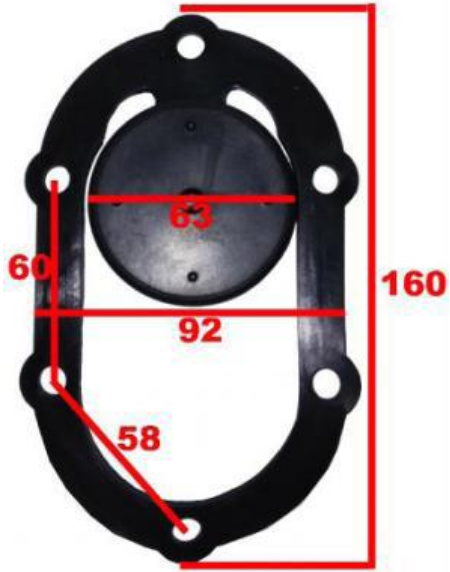

788800047

JUNTA VALVULA ASPIRACION MTB-40 TIPO W

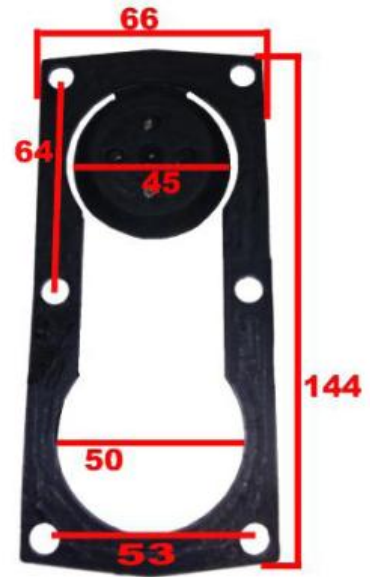

788800048

GENERADORES

883GEN720



883GEN1050L



883GEN2500



883GEN4500



REFERENCIA	883GEN720	883GEN1050L	883GEN2500	883GEN3000	883GEN4500
Tipo motor	2T AL 2%	OHV100	OHV200	OHV200	OHV390
Max.potencia salida	1,8HP/3000rpm	3.0HP/3600rpm	6.5HP/3600rpm	6.5HP/3600rpm	13HP/3600rpm
Sistema de arranque	MANUAL	MANUAL	MANUAL	MANUAL	MANUAL
Capacidad deposito	4.0L	5.5L		15L	
Horas de uso continuo	9h	9h		13h	
Nivel sonoro a 7 m.	61dB	69dB	67dB	67dB	93dB
Voltaje	230/50hz	230/50hz	230/50hz	230/50hz	230/50hz
Potencia/Máx. potencia	720W	1050W	2.75Kw/3,12KVA	2.0Kw/2,7KVA	5,25Kw/5,62KVA
Peso Neto, NW	20Kg	29Kg	43Kg	54Kg	76Kg
Dimensiones	360X380X300	470X420X380		710X460X460	

Estos articulos no son originales, son adaptables a diferentes marcas.

GENERADORES



REFERENCIA	883GEN6500C	883GEN6500	WM50GFE	883GEN6500T
Tipo motor	OHV 390	OHV 390	OHV 390	OHV 390
Max.potencia salida	13HP / 3600rpm	13HP / 3600rpm	13HP / 3600rpm	13HP / 3600rpm
Sistema de arranque	MANUAL	Manual	Electrico/Manual	Manual
Capacidad deposito	3.6 L	25 L	25 L	25L
Horas de uso continuo	9 h	9 h	9 h	9h
Nivel sonoro a 7 m.	97 dB	76 dB	76 dB	79 dB
Voltaje	230V / 50Hz	230V / 50Hz	230V / 50Hz	230V-380 / 50Hz
Potencia/Máx. potencia	5,0 Kw / 5,5 KVA	5,0 Kw / 5.5 KVA	5,0 Kw / 5.5 KVA	5,0 Kw / 5.5 KVA
Peso Neto, NW	86 Kg	86 Kg	94 Kg	86 Kg
Dimensiones	700x525x560	700x525x560	700x525x560	700x525x560



REFERENCIA	883GEN8500E	883GEN9500T		
Tipo motor	OHV 440	OHV 620		
Max.potencia salida	16HP / 3600rpm	20HP		
Sistema de arranque	Electrico	Electrico y Manual		
Capacidad deposito	25L	26L		
Horas de uso continuo	9h			
Nivel sonoro a 7 m.	97 dB	90 dB		
Voltaje	230V / 50Hz	230V-400V / 50Hz		
Potencia/Máx. potencia	8.1 KVA	11.9 KVA		
Peso Neto, NW	95 Kg	158 Kg		
Dimensiones	690x535x575	990x690x750		

GENERADORES

ALTERNADOR 2800 W



HAC3100

ALTERNADOR 4100 W

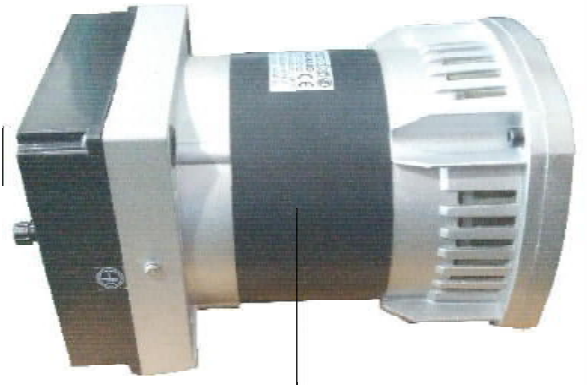

HAC4800

ALTERNADOR 5800 W



HAC6600

GENERADORES

ALTERNADOR 2800 W MOTOR 6,5 CV.



883ALT2800C
883ALT2800H

MOTOR OHV 200
MOTOR HONDA GX200

ALTERNADOR 4100 W MOTOR 9 CV.



883ALT4100C
883ALT4100H

MOTOR OHV 270
MOTOR HONDA GX270

ALTERNADOR 5800 W MOTOR 13 CV



883ALT5800C
883ALT5800H

MOTOR OHV390
MOTOR HONDA GX390

RECAMBIOS GENERADORES

<p>DEPOSITO COMBUSTIBLE</p>  <p>188650014 25L. 883GEN6500 188250005 15L. 883GEN2500 188105017 883GEN1050</p>	<p>FILTRO GASOLINA VASO PARA 883GEN2500-6500</p>  <p>78006008</p>	<p>FILTRO DEPOSITO COMBUSTIBLE GENERADOR PARA 883GEN1050</p>  <p>1881050014 883GEN1050 188650002 883GEN6500</p>
<p>TAPON DEPOSITO</p>  <p>188250003 883GEN2500 188650001 883GEN6500 1881050015 883GEN1050</p>	<p>TUBO GASOLINA</p>  <p>188250027 883GEN2500 188650021 883GEN6500</p>	<p>MEDIDOR DE ACEITE</p>  <p>188650020 883GEN6500</p>
<p>AFORADOR GENERADOR 2500-6500</p>  <p>188250001</p>	<p>TUBO DE ESCAPE</p>  <p>188250025 888GEN2500 188650021 883GEN6500</p>	<p>TUBO DE ESCAPE</p>  <p>1881050006 883GEN1050</p>

RECAMBIOS GENERADORES

INTERRUPTOR CIRCUITO AC.



188650006 883GEN6500
188250020 883GEN2500
188300020 GEN300

ENCHUFE GENERADOR 6500



188650007 883GEN6500
188250019 883GEN2500

BORNES POSITIVO/NEGATIVO
G2500-6500



188250017

REGULADOR DE VOLTAJE

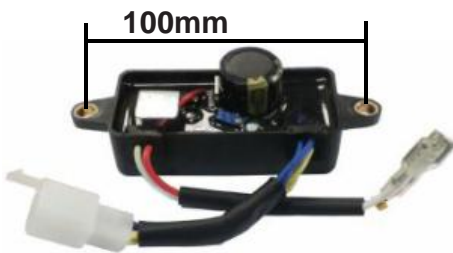

188250011 888GEN2500

REGULADOR DE VOLTAJE



188650011 883GEN6500

FUSIBLE GENERADOR PARA
883GEN2500-6500



188250018

BATERIA GEL 12 V 15 AH 20 HR



FM12170C

INTERRUPTOR



188250022 883GEN2500
188650004 883GEN6500

CONJUNTO DIODO



188250026 883GEN2500
188650017 883GEN6500

RECAMBIOS GENERADORES

PUENTE RECTIFICADOR



188250012 883GEN2500
188650010 883GEN6500

TERMINAL ELECTRICO



188250009 883GEN2500
188650009 883GEN6500

ROTOR GEN2500



188250015 883GEN2500
188650013 883GEN2500

MEDIDOR DE VOLTAJE



188250021 883GEN2500
188650011 883GEN6500
1881050063 883GEN1050

ESCOBILLAS ALTERNADOR



188250007 883GEN2500
188650012 883GEN6500

SOPORTE CONTROL REGULACION PARA 883GEN2500



188250028

SOPORTE CONTROL REGULACION PARA 883GEN6500

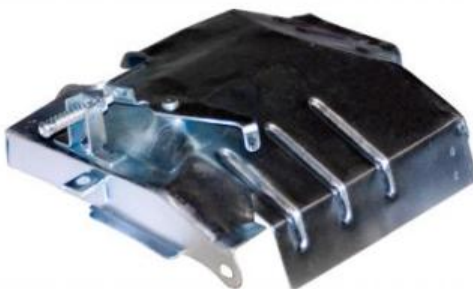

188650022

LLAVE ARRANQUE



35196X

ATENUADOR VIBRACIONES



188090071 883GEN2500
188090072 883GEN6500

RECAMBIOS GENERADORES

VENTILADOR 883GEN2500



188250016

PATA DE GOMA PARA 883GEN2500-6500



188090070

SOPORTE ALTERNADOR GEN1050L



1881050039

KIT 2 RUEDAS NEUMATICAS + SOPORTE PARA 883GEN6500



883GENRUE1

ELEMENTO FILTRO AIRE



188250023
188650016

883GEN2500
883GEN6500

GRIFO COMBUSTIBLE

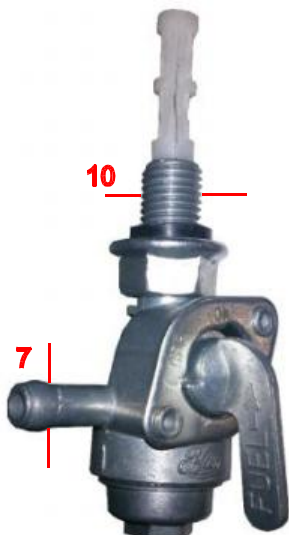

122045

883GEN2500

CARBURADOR



78008094

883GEN2500

RECAMBIOS GENERADORES

CARBURADOR 883GEN6500T Y
883GEN190E



78008098

INTERRUPTOR ON/OFF GEN3000



18830022

CARBURADOR



78008096

PARA 883GEN6500

SOPORTE SILENCIADOR
GEN 1050L



1881050019

MOTOSOLDADOR

883GEN190E



	883GEN190E
Tipo motor	OHV390
Max. potencia salida	13HP / 3600rpm
Sistema arranque	Electrico / Manual
Capacidad deposito	25 L
Max. horas uso continuo	9 h
Nivel sonoro a 7 m.	76 dB
Voltaje / Frecuencia	230V / 50Hz
Max. potencia generador	2,2 Kw
Max. potencia soldador	2,75 KVA 50-190A/h
Peso neto	90 Kg
Dimensiones	695x558x572

RECAMBIOS

CONMUTADOR DE AC



188190007

LLAVE ARRANQUE



35196X

PANEL DE CONTROL



188190003

RECTIFICADOR



188190014

TRANSFORMADOR



188190012

DIODO



188190013

ENSAMBAJE DIODO



188190015

AJUSTADOR DE CORRIENTE



188190008

MEDIDOR DE GASOLINA + AFORADOR



18825001

RECAMBIOS MOTOSOLDADOR

ENCHUFE



188190004

AUTOESTRANGULADOR



188190006

LAMPARA PILOTO



188190009

INTERRUPTOR CORTA CORRIENTE



188190034

ESTATOR



188190026

REACTOR



188190076

TAPA REACTOR



188190078

INTERCAMBIADOR



188190011

ESCOBILLAS CARBON

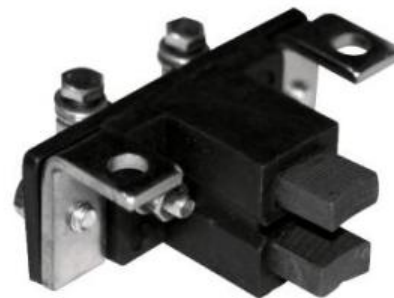

188190021

CONDENSADOR 100V 200uF



188190088

RESISTENCIA



188190089

TERMINALES



188190019

RECAMBIOS MOTOSOLDADOR

<p>TERMINALES</p>  <p>188190010</p>	<p>CAMISA AISLANTE</p>  <p>188190020</p>	<p>TAPON ACEITE (R,27)</p>  <p>78015002</p>
<p>DEPOSITO DE GASOLINA</p>  <p>188650014</p>	<p>TAPON DEPOSITO DE GASOLINA</p>  <p>188650001</p>	<p>PROTECTOR EJE CIGÜEÑAL</p>  <p>188190029</p>
<p>PROTECTOR VENTILADOR</p>  <p>188190028</p>	<p>ESTRANGULADOR COMPLETO</p>  <p>188190061</p>	<p>JUNTA ESTRANGULADOR</p>  <p>188190060</p>
<p>CARBURADOR</p>  <p>188190063</p>	<p>SEPARADOR CARBURADOR</p>  <p>188190064</p>	<p>JUNTA SEPARADOR CARBURADOR</p>  <p>188190065</p>

RECAMBIOS MOTOSOLDADOR

<p>TUBO ESCAPE</p>  <p>188190081</p>	<p>JUNTA TUBO ESCAPE</p>  <p>188190079</p>	<p>SILENCIADOR COMPLETO</p>  <p>188190084</p>
<p>PROTECTOR EXTERIOR SILENCIADOR</p>  <p>188190083</p>	<p>PROTECTOR INTERIOR SILENCIADOR</p>  <p>188190087</p>	<p>CASQUILLO SILENCIADOR Ø8.5</p>  <p>188190085</p>
<p>FILTRO AIRE COMPLETO</p>  <p>188190069-74</p>	<p>ELEMENTO FILTRO AIRE</p>  <p>188190069</p>	<p>SOPORTE FILTRO AIRE</p>  <p>188190068</p>
<p>FILTRO GASOLINA VASO</p>  <p>188650005</p>	<p>SOPORTE BRAZO GOBERNADOR</p>  <p>188190075</p>	<p>VALVULA UNIDIRECCIONAL</p>  <p>188190058</p>

MOTORES 2TIEMPOS

MOTOR 2 TIEMPOS



2T25
2T32

25cc
32,6cc

MOTOR 2 TIEMPOS



2T42
2T51

42,7cc
51,7cc

MOTOR 2 TIEMPOS 64 c.c (4HP) EMBRAGUE 78Ø
INTERCAMBIABLE CON ALPINA, KAWASAKI, ECHO, CIFARELLI



2T64



64cc

MOTORES 4TIEMPOS CON ZAPATAS DE EMBRAGUE

MOTOR DE 1,5 HP 4 TIEMPOS



71ZSOHV31



MOTORES 2TIEMPOS

MOTOR GASOLINA MT-25 (4T) OHC



5090MT25H

MOTOR GASOLINA MT-35 (4T) OHC



5090MT35H

MOTOR GASOLINA OHV 2,5 HP CIG 15X50



883H100

MOTORES OHV

MOTOR GASOLINA H100 2,5 HP



883H100SD

MOTOR DE 2,4 Y 2,8 HP



883OHV080
883OHV090

SALIDA "P" 15,8 X 50
SALIDA "P" 15,8 X 50

MOTOR 100 c.c., 3cv VERSION PISON



883OHV100

MOTOR REDUCCION Y EMBRAGUE CON SENSOR DE ACEITE



REFERENCIA

HP

DESCRIPCIÓN

SALIDA

883OHV200SR	6,5HP
883OHV200SR1	6,5HP
883OHV270SR	9HP
883OHV270SR1	9HP
883OHV390SR	13HP
883OHV390SR1	13HP

CON REDUCTORA Y EMBRAGUE	20x48
CON REDUCTORA	20x48
CON REDUCTORA Y EMBRAGUE	22x60
CON REDUCTORA	25x60
CON REDUCTORA Y EMBRAGUE	22x60
CON REDUCTORA	25x60

MOTORES OHV

MOTOR DE 4,0 HP



883OHV120SB
883OHV120L

SALIDA 18 X 50
SALIDA 20 X 50

MOTOR SUBARU EX 17 ESPECIAL
MOTOAZADA (19X60) 6CV



883ROBIN160LM

MOTOR GASOLINA



HONDA

883HONDA160L
883HONDA160T CON ALARMA
8836HONDA160LM (ESPECIAL MOTOAZADA)

SALIDA 20 X 50
SALIDA 20 X 50
SALIDA 19 X 60

MOTOR GASOLINA

HONDA



883HONDA200V

MOTOR GASOLINA

HONDA



883HONDA270V

MOTORES OHV

MOTOR DE 5,5 HP



883OHV160L
883OHV160QB
883OHV160V

SALIDA 20 X 50
SALIDA 19 X 58,5
SALIDA 72,2X19

MOTOR DE 5,5 HP



883OHV160EQB ARRANQ.ELEC. SALIDA 19 X 58,8

MOTOR DE 6,5 HP



883OHV200SB
883OHV200V
883OHV200Q

SALIDA 20 X 50
SALIDA 19,17 X 72,7
SALIDA 19 X 58.5

MOTOR DE 6,5 HP ESPECIAL MOTOAZADA



883OHV200VM SALIDA CONICA 20-15 X 30

MOTOR DE 7,0 HP



883OHV240Q
883OHV240L
883OHV240V

CIG. 19x58,5
CIG. 20x60
CIG.22,16 X 106

MOTOR DE 9,0 HP



883OHV270V
883OHV270Q
883OHV270S

SALIDA 22,16 X 106
SALIDA 25,8 X 72,2
SALIDA 25 X 60

MOTORES OHV

MOTOR DE 9,0 HP



883OHV270ESB ARRANQ.ELEC. SALIDA 25 X 60
883OHV270EV ARRANQ.ELEC. SALIDA 103X 22,16

MOTOR DE 11 HP



883OHV340V SALIDA 22,16 X 106

MOTOR DE 13 HP



883OHV390S SALIDA 25 X 60
883OHV390V SALIDA 22,16 X 106
883OHV390Q SALIDA 25 X 72,2

MOTOR DE 13 HP CON ARRANQUE ELECTRICO



883OHV390ES SALIDA 25 X 60
883OHV390EQB SALIDA 25 X 72,2
883OHV390EV SALIDA 106X22,6

MOTORES OHV

MOTOR 4 TIEMPOS 2 CILINDROS 20 HP "Q" ARRANQUE ELECTRICO



883GX620Q

MOTOR 4 TIEMPOS 2 CILINDROS 20 HP "V" ARRANQUE ELECTRICO

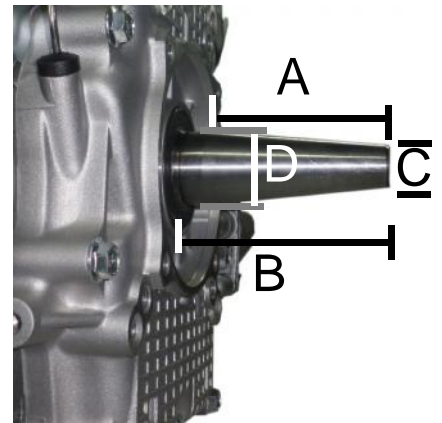
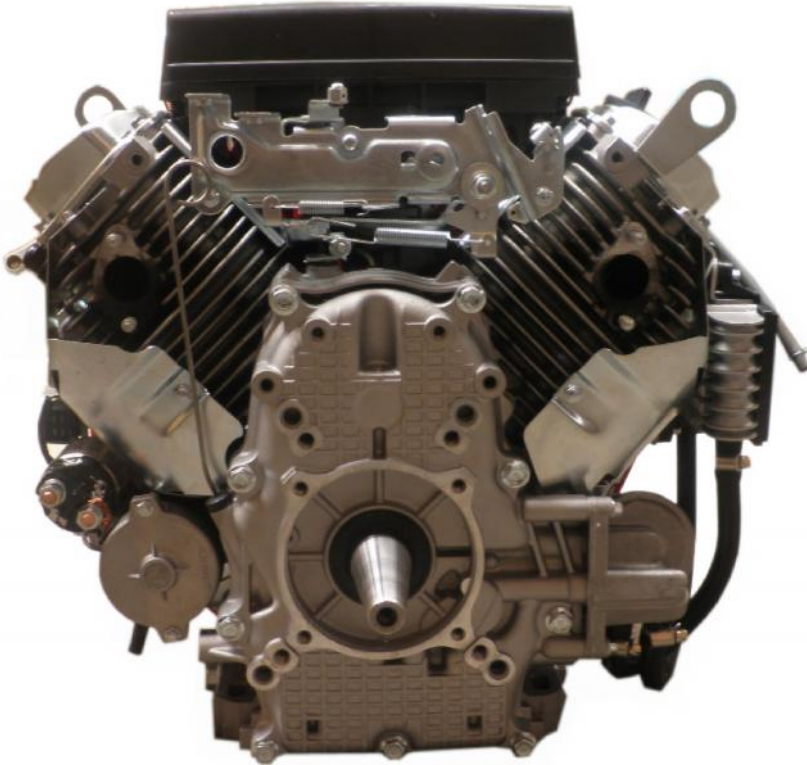

	A	B	C	D
883GX620V	83	95	20	35

Estos articulos no son originales, son adaptables a diferentes marcas.

MOTORES OHV HORIZONTALES

MOTOR HORIZONTAL



MCTC40

SALIDA 22x44

MOTOR HORIZONTAL



MCTC46

SALIDA 22x52

MOTOR HORIZONTAL



MCTC51

SALIDA 22x60

MOTOR HORIZONTAL



DETALLE SALIDA ESTRIADA



924001-1

SALIDA 12 ESTRIAS Ø17x55

MOTORES DIESEL

MOTOR DIESEL DE 4,7 HP. (TIPO LOMBARDINI) SALIDA CONICA 23



A247L

3000-3600RPM

MOTOR DIESEL DE 10 HP.

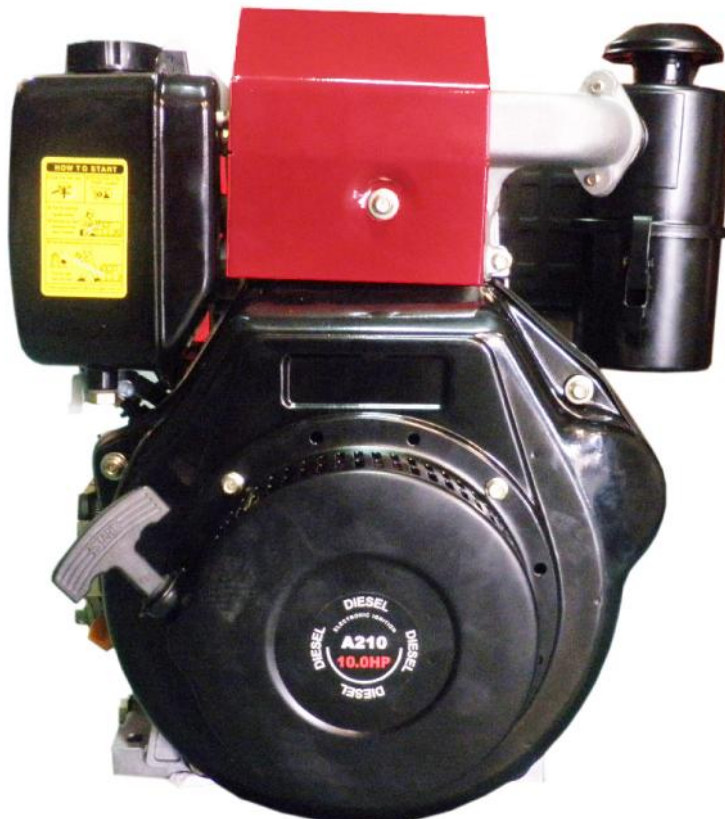

A210L
A210EL
A210Q

(TIPO LOMBARDINI) SALIDA CONICA 23
(TIPO LOMBARDINI) SALIDA CONICA 23
SALIDA DE Ø25

ARRANQUE MANUAL 3000-3600RPM
ARRANQUE ELECTRICO 3000-3600RPM
S ARRANQUE MANUAL 3000-3600RPM

SALIDAS MOTORES OHV

OHV80
OHV90
CHAVETA P

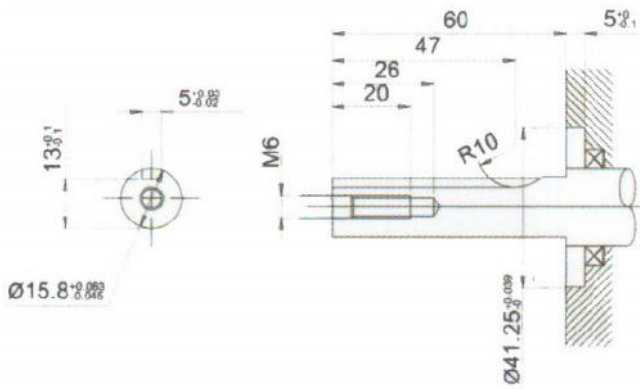

OHV120
CHAVETA S

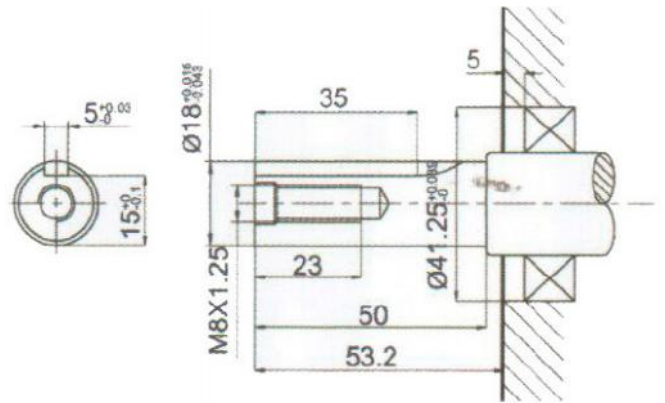

OHV160
CHAVETA L

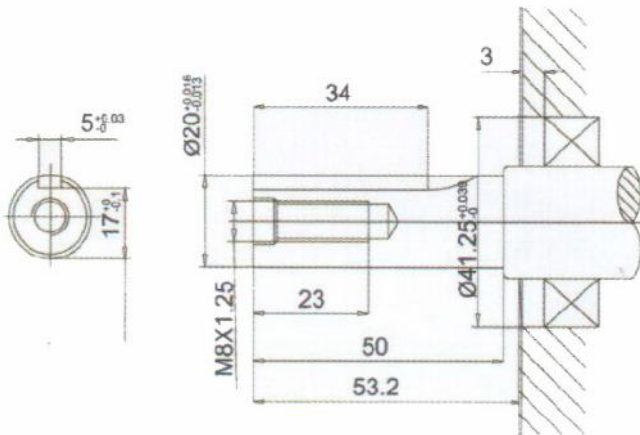

OHV160
CHAVETA Q

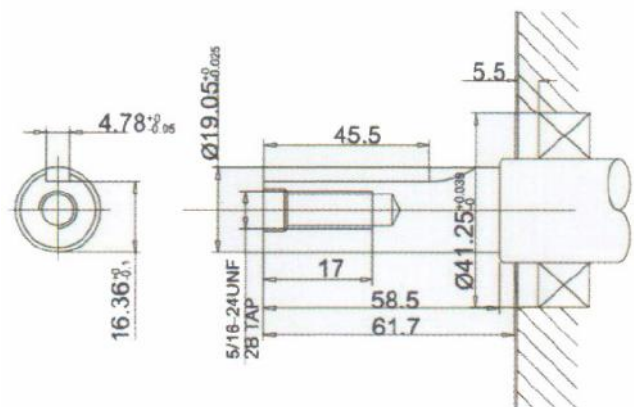

OHV200
CHAVETA S

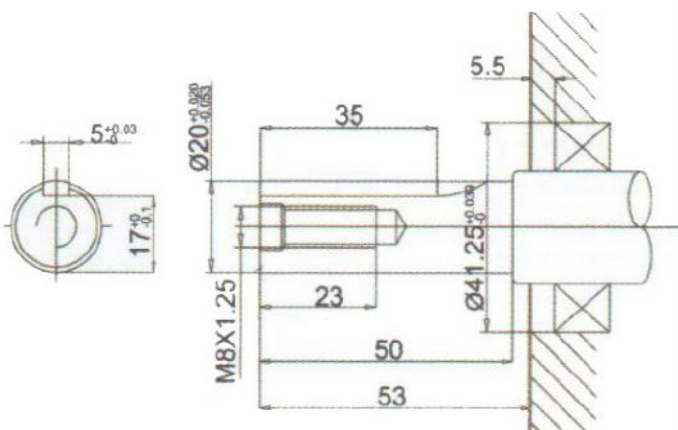

OHV200
CHAVETA V

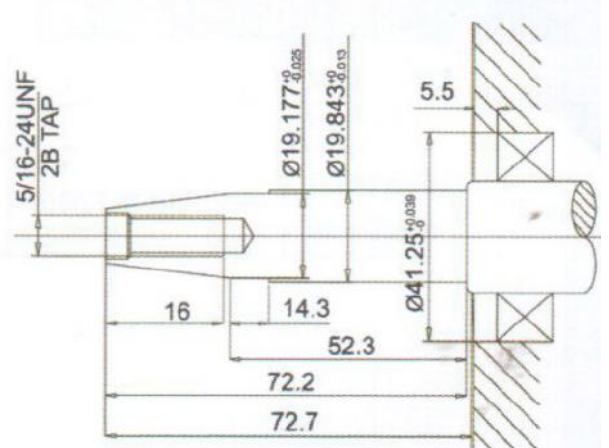

SALIDAS MOTORES OHV

OHV240
OHV270
CHAVETA Q

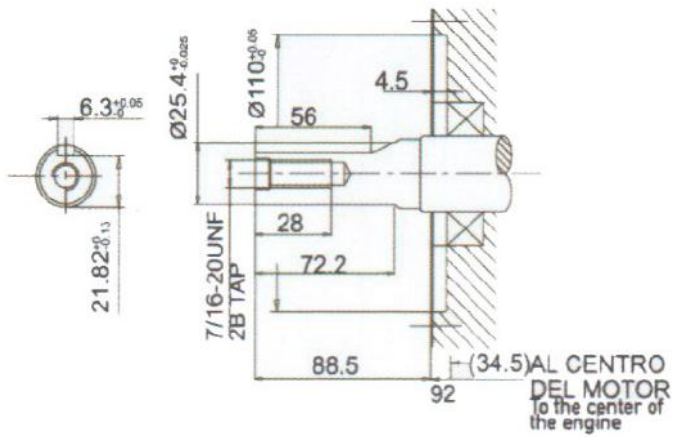

OHV240
OHV270
CHAVETA S

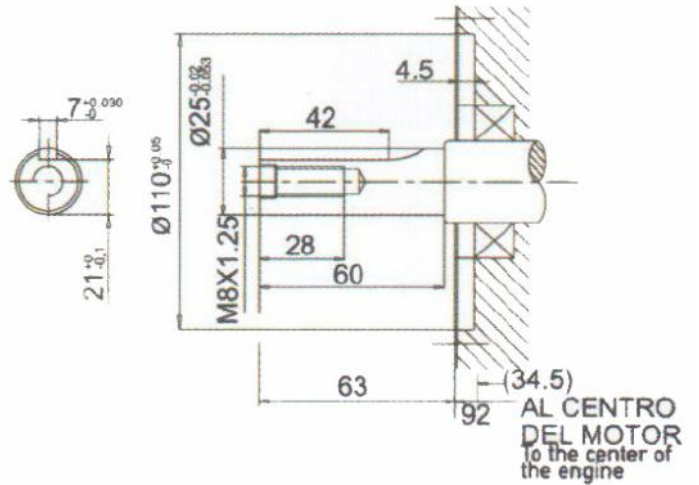

OHV240
OHV270
CHAVETA V

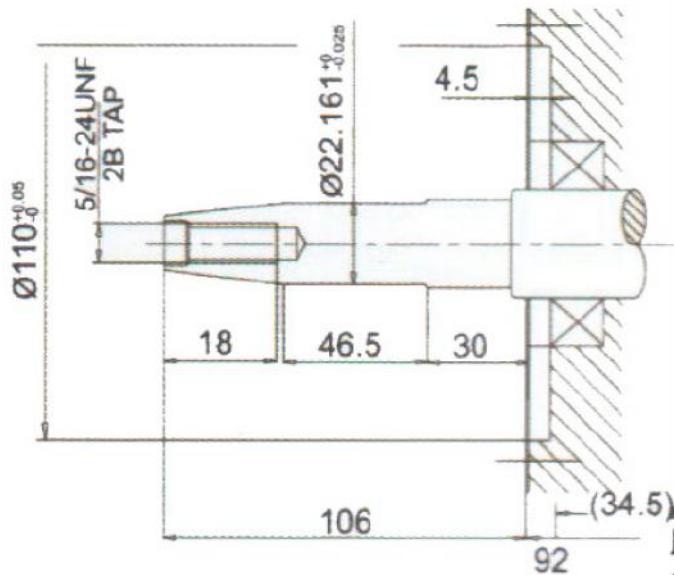

OHV340
OHV390
OHV390E
CHAVETA Q

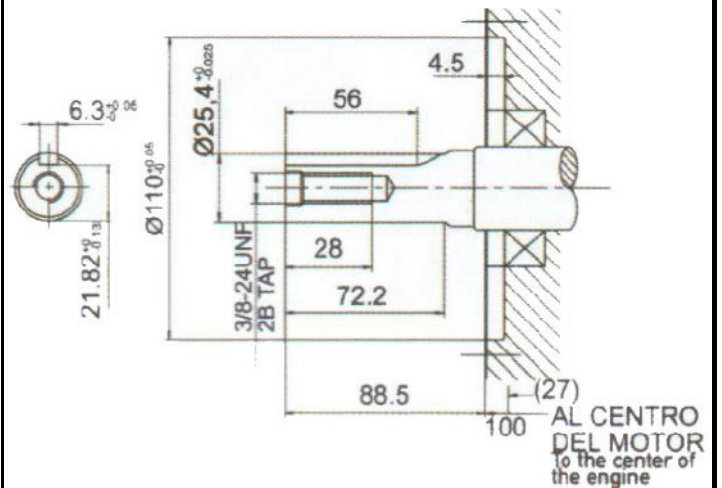

OHV340
OHV390
CHAVETA S

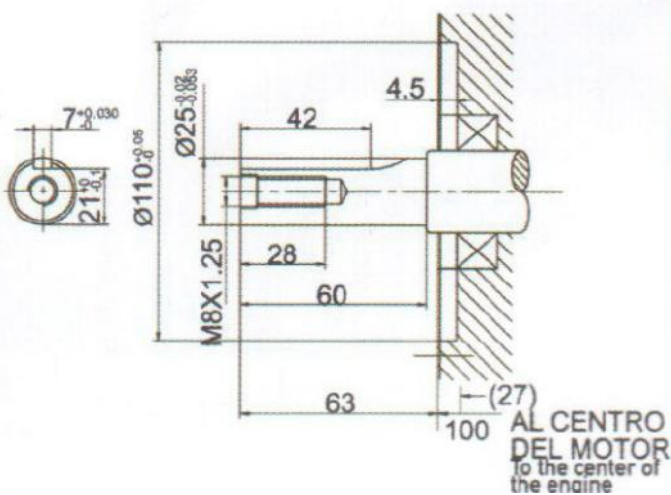

OHV340
OHV390
CHAVETA V

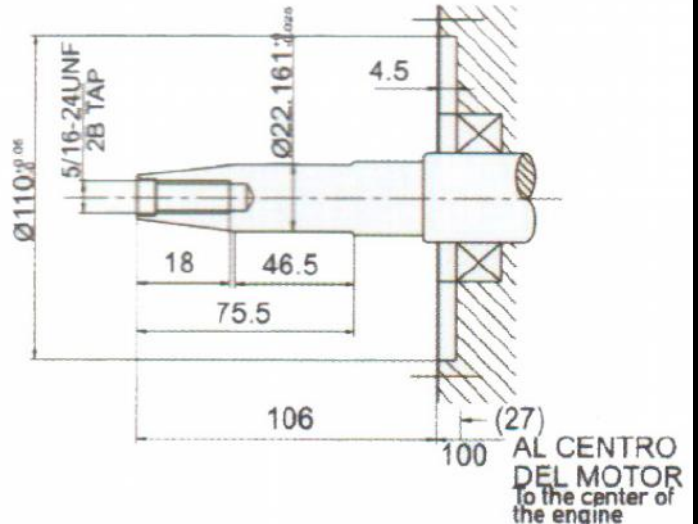

REDUCTORAS

REDUCTOR COMPLETO 2:1 CON EMBRAGUE



78001501
78001502

PARA EL 883OHV200SR
PARA EL 883OHV390SR

SALIDA
SALIDA

RECAMBIOS REDUCTORAS

CADENA 36 PASOS



78001503

SEPARADORE EMBRAGUE



78001508

PIÑON CENTRAL

A -- Ø 35mm
B -- Ø 57mm - 28Z
C -- 15mm
L -- 53mm

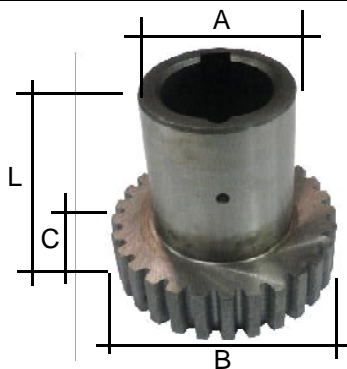

78001504

A -- Ø 35mm
B -- Ø 61mm -14Z
C -- 17mm
L -- 52mm

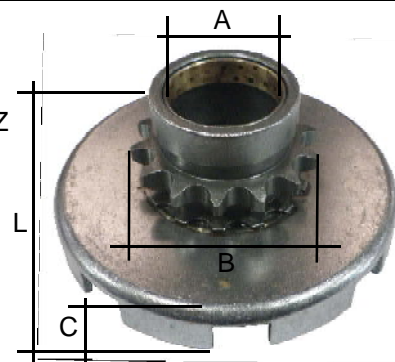

78001505

MUELLE Ø 9mm X 17mm



78001506

RECAMBIOS OHV

<p>MANGUITO GASOLINA</p>  <p>78006006 OHV 80-90 78006007 OHV120-160</p>	<p>INDUCTOR</p>  <p>FIGURA 1 FIGURA 2</p> <p>78022011 FIGURA 1 OHV80-90 78022012 FIGURA 2 OHV80-90</p>	<p>CARCASA VENTILADOR</p>  <p>NOVEDAD</p> <p>78004006 OHV80-90</p>
<p>INDUCTOR</p>	<p>CORONA DEL EJE</p>  <p>780260021 OHV80-90</p>	<p>CORONA DE ARRASTRE</p>  <p>78026020 OHV80-90</p>
<p>ENGRANAJE DISTRIBUCION</p>  <p>78026024 OHV140-200 78026026 OHV240-390</p>	<p>ARBOL DE LEVAS</p>  <p>78026022 OHV80-90 78026023 OHV110-120 78026025 OHV140-160 78026026 OHV200 78026027 OHV240-270 78026028 OHV340-390</p>	
<p>ALARMA ACEITE</p>  <p>78029000 OHV 80-90 78029001 OHV 110-200 78029002 OHV 270-390 78029003 H100</p>	<p>INTERRUPTOR ENCENDIDO</p>  <p>78007001 OHV160-270-390</p>	<p>INTERRUPTOR ENCENDIDO</p>  <p>78007002 GX-35</p>

RECAMBIOS OHV

REGULADOR-RECTIFICADOR
OHV 620



78017011

LLAVE ARRANQUE



35196X

CONJUNTO LLAVE ARRANQUE



35013X

CONJUNTO LLAVE ARRANQUE
OHV 620

DIODO PARE MOTOR OHV 620



35014X

PIÑÓN REGULADOR OHV 620



78008020

REGULADOR GAS OHV 160



788634260

REGULADOR GAS OHV-MT



785734260
789834260

270
390





VOLANTE DEL ARRANQUE



78004003

OHV80-90

RECAMBIOS OHV

<p>COJINETE ARRANQUE</p>  <p>78004004 OHV80-90</p>	<p>VENTILADOR 140</p>  <p>78004007 H100</p>	<p>VENTILADOR Ø168</p>  <p>78004008 OHV160</p>
<p>VENTILADOR Ø 200</p> <p>78483000 OHV270</p>	<p>VENTILADOR</p>  <p>78004005 OHV80-90</p>	

RECAMBIOS OHV

PALANCA REGULADOR



78022000 OHV 80-90
 78022001 OHV 160
 78022002 OHV 270
 78022003 OHV 390

KIT PALANCA REGULADORA



78022000 OHV80-90

SOPORTE CONTROL REGULACION



78022004 OHV120 -160

PALANCA LEVA CARBURADOR



78023001 OHV160
 78023002 OHV270
 78023003 OHV390

EJE CONECTOR CARBURADOR



78023006 OHV80-90

MUELLE BRAZO



78020000 OHV 80-90
 78020006 OHV 100-152
 78020001 OHV 140-160
 78020005 OHV 200
 78020002 OHV 240-270

MUELLE RETORNO GAS



78021000 OHV 80-90
 78021001 OHV 140-160-200
 78021002 OHV 240-270
 78021003 OHV 340-390

GOBERNADOR DE GAS



78019001 OHV 160
 78019002 OHV 270
 78019003 OHV 390

BRAZO GOBERNADOR



78020004 OHV80-90

EJE GOBERNADOR



78019000 OHV80-90

LLAVE BUJIAS

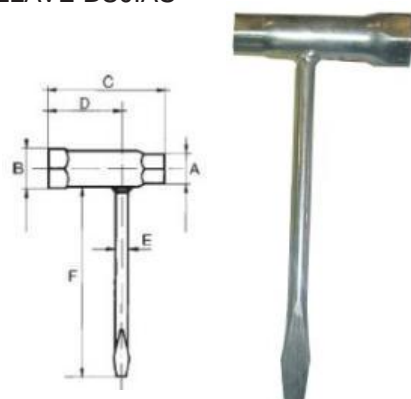

REF.	A	B	C	D	E	F
11281	17	21	70	34	8	140

LLAVE BUJIAS



11317 22x26

ARRANQUES ADAP. ALPINA

ARRANQUE ALPINA 42, 52



78011026

ARRANQUES ADAP. B&S

ARRANQUE COMPLETO
B&S SERIE 19G



78011020

REF.OEM 693900

ARRANQUE COMPLETO B&S
12XCID Vertical



78011021

REF.OEM 497680

ARRANQUE COMPLETO
VANGUARD 184Ø



AR005

REF.OEM 6922102

ARRANQUE COMPLETO GEN
950/1000



AR012

ARRANQUE COMPLETO B&S
5HP-SERIE 13



78011022

REF.OEM 496650

ARRANQUE COMPLETO B&S
EUROPA-QUANTUM



78011023

REF.OEM 497598

ARRANQUES ADAP. B&S

ARRANQUE COMPLETO 1250



AR006

KITS REPARACION B&S

KIT REPARACION ARRANCADOR B&S



KRA005

REF OEM 692102

KIT REPARACION ARRANQUE B&S



KRA001

REF OEM 692299

TOPE DE GOMA BRIGGS
J.D,3 & 3-1/2HP



TPG001

REF OEM 68618

TOPE DE GOMA AD BRIGGS
J.D. 6, 7, 8, 10, 11, 12HP



TPG002

REF OEM 68848

TAPA MUELLE 3, 3.5, 4, 5HP B&S



TMU001

REF OEM 690766

MUELLES B&S

MUELLE ARRANCADOR B&S



MUA015

REF OEM 491889

MUELLE ARRANCADOR B&S 3, 3.5 ,4 HP





MUA002

REF OEM 390066

ARRANQUES ADAP. B&S

<p>MUELLE ARRACANDOR 2-16HP</p>  <p>MUA003 REF OEM 491889</p>	<p>MUELLE ARRACANDOR B&S</p>  <p>MUA004</p>	<p>MUELLE ARRACANDOR 2-16HP</p>  <p>MUA003 REF OEM 491889</p>
--	---	--

POLEAS ARRANQUE B&S

<p>POLEA ARRANQUE B&S JD 2,3,3-1/2,4HP</p>  <p>P0002 REF OEM 280439</p>	<p>POLEA ARRANQUE B&S JD 3/3,5/4 HP VERT</p>  <p>P0035 REF OEM 299948</p>
---	--

<p>POLEA CON MUELLE ARRANQUE VERTICAL 5-6HP</p>  <p>P0033 REF OEM 281504</p>	<p>POLEA ARRANQUE B&S</p> <p>P0038 REF OEM 498144</p>
---	---

<p>POLEA ARRANQUE QUANTUM 3-1/2HP VERT</p>  <p>P0034 REF OEM 490877</p>	<p>POLEA ARRANQUE JD 5-7-8HP</p>  <p>P0003 REF OEM 295871</p>
--	---

ARRANQUES ADAP. B&S

POLEAS ARRANQUE B&S

POLEA ARRANQUE B&S JD 2,3,3-1/2,4HP

POLEA ARRANQUE B&S JD 2,3,3-1/2,4HP

P0008

REF OEM 280918

P0032

REF OEM 499901

POLEA ARRANQUE BRIGGS,JD,TORO

POLEA ARRANQUE BRIGGS,TORO,JD 5-1/2,5HP

P0031

REF OEM 493824

P0006

REF OEM 493824

POLEA ARRANQUE B&S

POLEA ARRANQUE B&S

P0007

REF OEM 499901

P0009

POLEA ARRANQUE B&S

POLEA ARRANQUE JD 5-7-8HP

P0001

P0003

ARRANQUES ADAP. B&S

TIRADORES ARRANQUE B&S

MANGO TIRADOR ARRANQUE AD BRIGGS , J.D



MTI006

REF OEM 393152

MANGO TIRADOR ARRANQUE B&S



MTI001

REF OEM 281434S

MANGO TIRADOR ARRANQUE B&S



MTI002

MANGO TIRADOR ARRANQUE AD B&S, JD
64X32mm



MTI003

REF OEM 491288

MANGO TIRADOR ARRANQUE AD B&S, J.D



MTI004

REF OEM 490652

MANGO TIRADOR ARRANQUE AD B&S, JD, NOMA
TECUMSEH, TORO



MTI005

REF OEM 590574

CUERDA ARRANCADOR CORTADA



78493100

5,0MM X 1,45Mts

78093100

4.5MM X 1,25Mts

ARRANQUES ADAP. HONDA

ARRANQUE COMPLETO PATILLAS PLANAS DE METAL CON CAZOLETA



78011012

OHV160

ARRANQUE OHV GXV140/GXV160K1

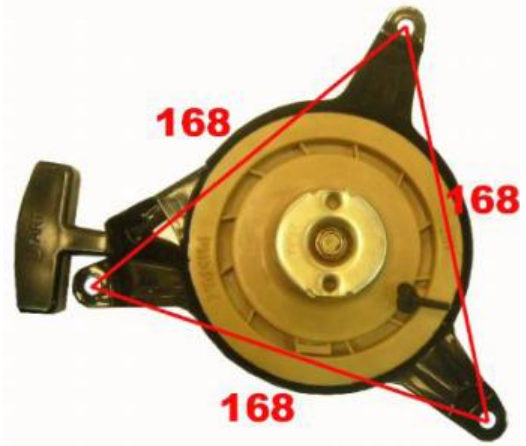

78011005

ARRANCADOR CORTACEPED V.M.



78100001

ARRANQUE GX25



AR014

REF.OEM 28400-Z0H-003

ARRANQUE CON POLEA TRINQUETE HONDA G150/200,GX110-120-140-160



AR001

ARRANQUE OHV 100-152 ESTRECHO 6 AGUJEROS



92152FP61E

ARRANQUE GC/GCV 135 160 ROJO



787523002

28400-ZE8-003ZB
28400-ZL8-013ZA
28400-ZM0-003ZA

ARRANQUE HONDA G150/200,GX110-120-140-160



AR013

REF.OEM 28400-883-040ZB

ARRANQUES ADAP. HONDA

ARRANQUE COMPLETO GEN-720

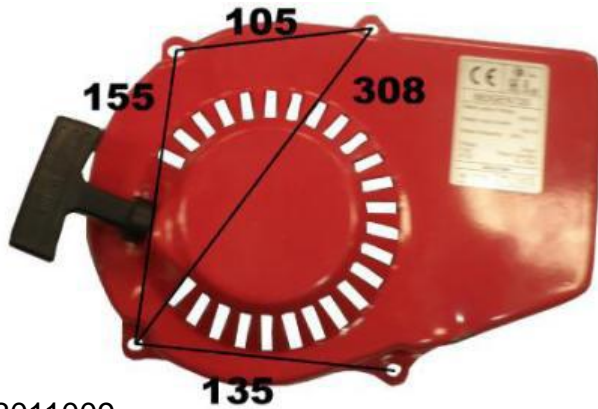

78011009

ARRANCADOR GX35



78011015

ARRANQUE COMPLETO GXH50, GXU50 .



78011017

ARRANQUE GXV 160 METALICO



78011018

ARRANQUE G100 FONDO ESTRECHO

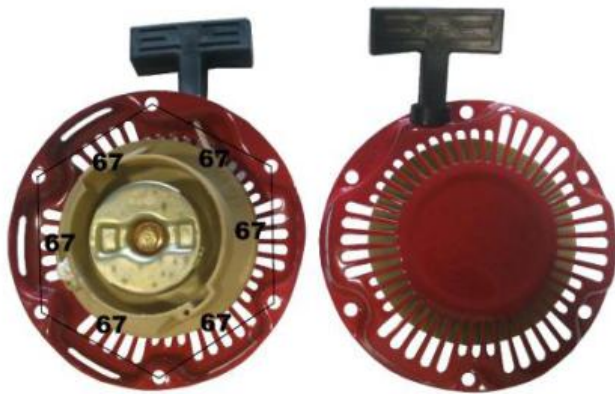

78011016

ARRANQUE G100 FONDO ANCHO



78011019

ARRANQUE OHV G150 - G200

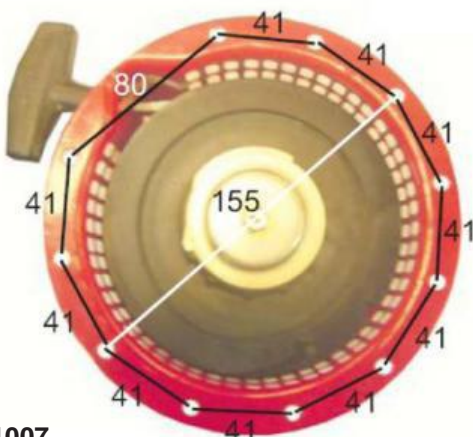

78011007

TAPA ARRANQUE COMPLETA OHV GC/GCV135/160

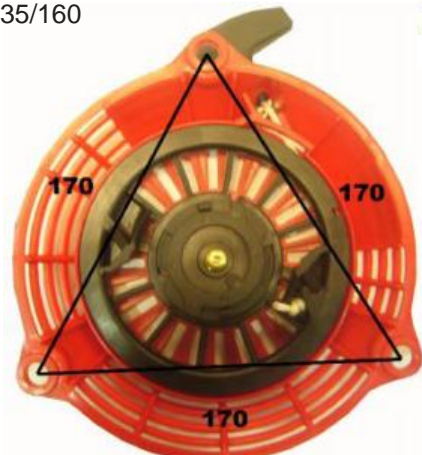

78011006

ARRANQUES ADAP. HONDA

ARRANQUE OHV GX 31



78011004

ARRANQUE GX 100



78011014

ARRANQUE COMPLETO



78011000

OHV 80-90

ARRANQUE COMPLETO TRINQUETES NYLON



78011001

OHV160

ARRANCADOR GX100
COMPACTADOR
METALICO



78011010

ARRANQUE GC135 160
GCV 135 160



78011013

ARRANQUE COMPLETO GATILLOS METALICOS



	MODELO	A	B
78011011	OHV 120/160/200	80	160
78011002	OHV 240/270	90	180
78011003	OHV 340/390	98	198

ARRANQUES ADAP. HONDA

KITS DE REPARACION HONDA

KIT REPARACIÓN ARRANQUE OHV 110-200 HONDA



188160127

KIT REPARACIÓN ARRANQUE OHV 110-200 HONDA



188160126

KIT REPARACIÓN ARRANQUE OHV 110-200 HONDA



78002100

KIT REPARACIÓN ARRANCADOR OHV 240-270 HONDA



188170131

KIT REPARACIÓN ARRANCADOR OHV 340-390 HONDA



78102100

KIT REPARACIÓN ARRANCADOR G150/200, GX160 VIEJO HONDA



KRA006

KIT REPARACIÓN ARRANCADOR GCV135/160 HONDA



KRA002

TAPA GUIA TRINQUETE NYLON OHV 110 A 200 HONDA



78023100

ARRANQUES ADAP. HONDA

KITS DE REPARACION HONDA

TRINQUETE ARRANCADOR NYLON OHV 110 A 200 HONDA



78203100

TRINQUETE ARRANCADOR METÁLICO OHV 110 A 200 HONDA



78503100

TRINQUETE ARRANCADOR METÁLICO OHV 240-270 HONDA



78113100

TRINQUETE ARRANCADOR METÁLICO OHV 340-390 HONDA



78603100

MUELLES HONDA

MUELLE ARRANCADOR



78004002
MUA005

OHV120-200
OHV240-390

MUELLE ARRANCADOR G150/200, GXV OLD HONDA



MUA014

REF OEM 28442-883-000

MUELLE ARRANCADOR GCV135/160 HONDA



MUA006

ARRANQUES ADAP. HONDA

POLEAS ARRANQUE HONDA

POLEA TRINQUETE ARRANCADOR OHV-MT-110-120 (NYLON) HONDA



78263100

POLEA TRINQUETE ARRANCADOR (METÁLICOS) OHV-MT-340-390 HONDA



78663100

REF OEM 28451-ZE3-W01

POLEA TRINQUETE ARRANCADOR OHV-MT-110-200 METÁLICOS PLANOS HONDA



78063100

POLEA TRINQUETE ARRANCADOR (METÁLICOS) OHV-MT-240-270 HONDA



78463100

REF OEM 28451-ZE2-W01

KIT REPARACIÓN ARRANCADOR OHV 340-390 HONDA



P0015

REF OEM 28415-ZG9-802

POLEA ARRANQUE TRINQUETES METÁLICOS REDONDOS GX110-GX200 HONDA



P0004

POLEA ARRANQUE G150/200, GX160 VIEJO HONDA



P0012

POLEA ARRANQUE GCV135/160 HONDA



P0016

ARRANQUES ADAP. HONDA

POLEAS ARRANQUE HONDA

POLEA ARRANQUE GX240, GX270 HONDA



P0013

REF OEM 28421-ZE2-W01

POLEA ARRANQUE GX340/390 HONDA



P0014

REF OEM 28421-ZE3-W01

POLEA ARRANQUE TRINQUETE NYLON GX110-GX200



P0011

POLEA ARRANQUE G100 HONDA



P0017

POLEA ARRANCADOR TRINQUETES METÁLICOS PLANOS OHV-MT-110-200 HONDA



78053100

REF OEM 28420-ZE1-003

ARRANQUES ADAP. HONDA

TIRADORES ARRANQUE HONDA

MANGO TIRADOR ARRANQUE 70 x 45mm
GCV135/160 HONDA



MTI008

REF OEM 28461-ZL8-003

MANGO TIRADOR ARRANQUE 67x 61mm
GX100/200 HONDA



MTI009

MANGO TIRADOR ARRANQUE 71 x 50mm
GX340/390 HONDA



78033100

REF OEM 28461-ZH8-003

CUERDA ARRANCADOR CORTADA



78493100

5,0MM X 1,45Mts

78093100

4.5MM X 1,25Mts

ARRANQUES ADAP. HUSQVARNA

ARRANQUE HUSQVARNA 51 55

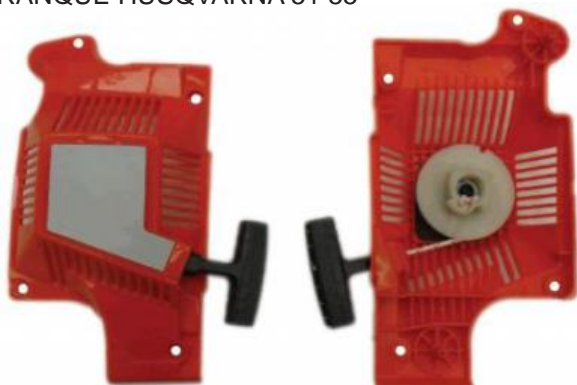

78011070

REF OEM 503608803

ARRANQUE HUSQVARNA 61, 66, 266, 268, 272

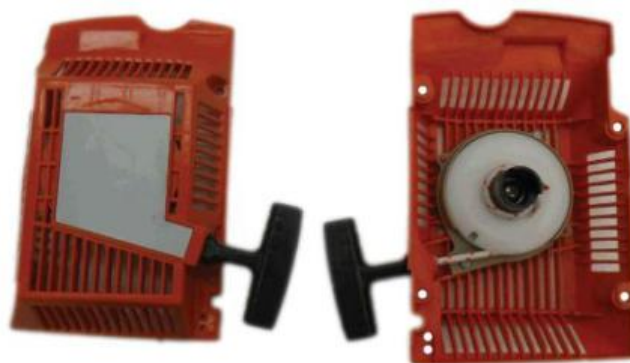

78011072

REF OEM 503615571

ARRANQUE HUSQVARNA 340, 345, 350.



78011074

REF OEM 537422901

ARRANQUE COMPLETO 359 HUSQVARNA



AR022

REF OEM 503930603

ARRANQUES ADAP. HUSQVARNA

ARRANQUE COMPLETO 365,372



AR023

REF OEM 503628171

ARRANQUE COMPLETO 281,288



AR019

REF OEM 501810006

ARRANQUE COMPLETO 395



AR004

REF OEM 503462402

POLEAS ARRANQUE HUSQVARNA

POLEA ARRANQUE



P0037

REF OEM 503859601

POLEA ARRANQUE 50,51,55



P0018

REF OEM 505303735

POLEA ARRANQUE 61,268,272



P0019

REF OEM 503102405

POLEA ARRANQUE 281,288



P0020

REF OEM 503484801

ARRANQUES ADAP. HUSQVARNA

MUELLES HUSQVARNA

MUELLE ARRANCADOR 268,288



MUA008

REF OEM 501520402

MUELLE ARRANCADOR 365,372



MUA009

REF OEM 503787201

TIRADORES ARRANQUE HUSQVARNA

MANGO TIRADOR ARRANQUE



MTI010

REF OEM 503543901

CUERDA ARRANCADOR CORTADA



78493100
78093100

5,0MM X 1,45Mts
4.5MM X 1,25Mts

ARRANQUES ADAP. KAWASAKI

ARRANQUE COMPLETO AD KAWASAKI TD40/48



AR026

REF OEM 49088-2166

KITS ARRANQUE KAWASAKI

KIT REPARACIÓN ARRANQUE TD40 KAWASAKI



KRA007

REF OEM 131652058

ARRANQUES ADAP. KAWASAKI

POLEAS ARRANQUE KAWASAKI

POLEA ARRANQUE HPH26K,TG18



P0022

REF OEM 59101-2051

POLEA ARRANQUE AD KAWASAKI



P0023

REF OEM 59101-2073

MUELLES KAWASAKI

MUELLE ARRANCADOR KAWASAKI



MUA010

ARRANQUES ADAP. KOMATSU

ARRANQUE COMPLETO G4K KOMATSU



AR027

ARRANQUE COMPLETO KOMATSU, REDMAX EB7000



AR028

REF OEM 1487-75101

ARRANQUES ADAP. KUBOTA

ARRANQUE COMPLETO
KUBOTA GS160-200



78011030

ARRANQUE COMPLETO
KUBOTA GS300



78011031

ARRANQUES ADAP. LOMBARDINI

CUERDA DE ARRANQUE



104310
104330

9x1700
6x1500

POLEA AR, LOMBARDINI NYLON 5LD260- 6LD360-
LDA500- 520- 530 4 A



104740

POLEA AR, LOMBARDINI 6 AGUJEROS (4LD640-100)



108840

POLEA AR, LOMBARDINI LDA 400 490 510 3 A. 3 CANALES



105480

POLEA AR, LOMBARDINI 3LD510 LDA 450-510 3 A, 2
CANALES



104750

POLEA AR, LOMBARDINI ALUMINIO 5LD260 -6LD360-
LDA500- 520- 530 4 AGUJEROS



122570

ARRANQUES ADAP. LOMBARDINI

ARRANQUE LOMBARDINI -INTERMOTOR



113480

ARRANQUE LOMBARDINI 3LD 6LD 15LD

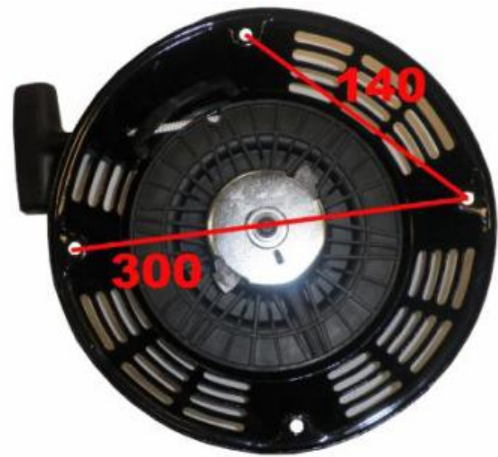

126410

ARRANQUES ADAP. MARUYAMA

ARRANQUE MARUYAMA AE200P MS056



78011060

ARRANQUE MARUYAMA AE500 BC500H



78011061

ARRANQUE MARUYAMA AE200 MS062



78011064

ARRANQUE MARUYAMA AE200 MS062



78011065

ARRANQUES ADAP. MARUYAMA

ARRANQUE MARUYAMA ME435A MD150DX



78011066

ARRANQUE MARUYAMA ME435A MD150DX



78011067

ARRANQUE MARUYAMA ME435A MD150DX



78011068

ARRANQUES ADAP. MIGARDEN

ARRANQUE COMPLETO MOCHILA FUMIGAR 20L



0410630-1



0407260-1

ARRANQUE COMPLETO MOTOR 25.4cc

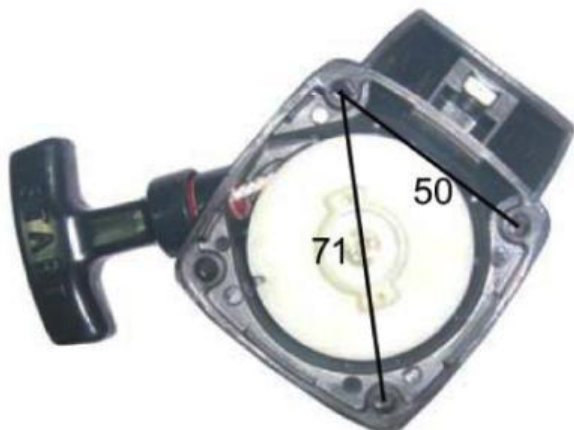

2T25-1

GATILLO ARRANCADOR MT-25 CON POLEA



901E34F81
901E34F82

MUELLE GATILLO

ARRANQUES ADAP. MIGARDEN

ARRANQUE COMPLETO MOTOR 32.6cc, 42.6cc, 51.7cc



78011035

ARRANQUE COMPLETO MOCHILA FUMIG. POLVO SOPLADOR



2T42-1

ARRANCADOR GRUPO MOTOR Y BOMBA VAC808B



VAC808B-2

ARRANQUE COMPLETO 45cc



0403450227

ARRANQUE COMPLETO 45cc



0403450227A

ARRANQUE COMPLETO 25cc



0403251116

ARRANQUE COMPLETO 72cc



0403720-4

ARRANQUE COMPLETO MOTOAZADA NOUKI



780011008

ARRANQUES ADAP. MIGARDEN

ARRANCADOR CPL MT-33



509002-2

CUERDA ARRANCADOR CORTADA



78493100

5,0MM X 1,45Mts

78093100

4.5MM X 1,25Mts

CUERDA DE ARRANQUE 5,5mm-100M UNIVERSAL



CUR001

CUERDA ARRANQUE



78514100

100 Mts x 2.5 mm

78104100

100 Mts x 2.8 mm

78016001

100 Mts x 4,5 mm

78016002

100 Mts x 3,5 mm

78016003

100 Mts x 4,0 mm

78016004

100 Mts x 5,0 mm

ARRANQUES ADAP. MITSUBISHI

ARRANQUE COMPLETO MITSUBISHI TL43

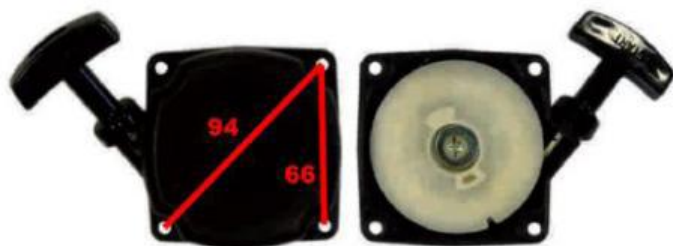

78011035

ARRANQUES ADAP. MITSUBISHI

KITS ARRANQUE MITSUBISHI

POLEA VOLANTE CPL TL23/26
MITSUBISHI



P0036

POLEAS ARRANQUE MITSUBISHI

POLEA ARRANQUE TL33, TL43, TL52
MITSUBISHI



P0005

ARRANQUES ADAP. ROBIN

ARRANQUE ROBIN EY 20-3-EH17-
EX17



78011044

REF OEM 227-50811-10

ARRANQUE ROBIN EY20 MODERNO

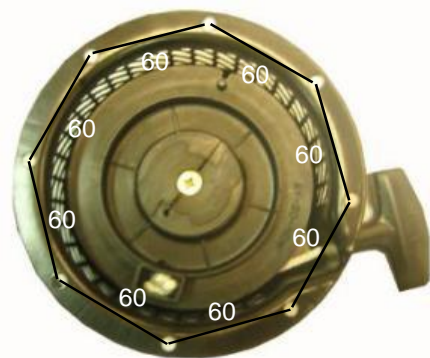

78011043

REF OEM 227-50211-00

ARRANQUE ROBIN EY15 MODERNO



78011042

ARRANQUE ROBIN EC10



78011041

ARRANQUES ADAP. ROBIN

ARRANQUE COMPLETO EY15 TIPO VIEJO



AR030

REF OEM 226-150211-00

KIT ARRANQUE ROBIN

KIT REPARACIÓN ARRANQUE EY15 NUEVO EY20



KRA003

POLEAS ARRANQUE ROBIN

POLEA ARRANQUE EY15, EY20 NUEVO



P0024

POLEA ARRANQUE EY20-3, EH17,
EX17 ROBIN



P0025

ARRANQUES ADAP. ROBIN

MUELLES ROBIN

MUELLE ARRANCADOR EC10,EY15/18/20



MUA011

ARRANQUES ADAP. STIHL

ARRANQUE COMPLETO MS361
STHIL



AR037

REF OEM 1135-080-2102

ARRANQUE STHIL TS350, TS360



78011088

ARRANQUE STHIL 038, 041, MS380, MS381



78011084

REF OEM 1119-080-1800

ARRANQUE STHIL 044, 046, MS440, MS460



78011085

ARRANQUE STHIL 065, 066,



78011086

ARRANQUE STHIL FS120, FS200,
FS250



78011087

ARRANQUES ADAP. STIHL

ARRANQUE STIHL MS170, MS180



78011080

REF OEM 1130-080-1800

ARRANQUE STIHL 021, 023, 025, MS210, MS230, MS250



78011081

REF OEM 1123-080-1802

ARRANQUE STIHL 024, 026, MS240, MS260



78011082

REF OEM 1121-080-2101

ARRANQUE STIHL MS340, MS360



78011083

REF OEM 1125-080-2105

KITS ARRANQUE STIHL

KIT REPARACIÓN ARRANQUE STIHL
024,026,FS450,MS240,MS260,MS361,FS450



KRA004

REF OEM 1125-195-7200

POLEAS ARRANQUE STIHL

POLEA ARRANQUE FS450 STIHL



P0030

REF OEM 4128-195-0400

POLEA ARRANQUE STIHL FS60/61/80/90



P0021

REF OEM 59101-2067

ARRANQUES ADAP. STIHL

POLEAS ARRANQUE STIHL

POLEA ARRANQUE 017, 018, 023, 025



P0026

REF OEM 1123-195-0400

POLEA ARRANQUE 024,026,MS240/260



P0028

REF OEM 1125-195-0401

POLEA ARRANQUE 036,044,046,MS360,MS440,MS460



P0029

REF OEM 1128-195-0400

MUELLES ARRANQUE STIHL

MUELLE ARRACANDOR 018,036,044,046, MS250/440/460



MUA012

REF OEM 1129-190-0601

MUELLE ARRANCADOR AD STIHL 024,026,MS240/260



MUA013

REF OEM 1118-190-0600

ARRANQUES ADAP. STHIL

TIRADORES ARRANQUE STIHL

MANGO TIRADOR ARRANQUE 024, 028, 031, 034, 038, 041, 070, FS220, FS280, BR320, 3400



MTI011

REF OEM 1121-195-3400

CUERDA ARRANCADOR CORTADA



78493100

5,0MM X 1,45Mts

78093100

4.5MM X 1,25Mts

ARRANQUES ADAP. TECUMSEH

ARRANQUE COMPLETO H30-70,HS40-50



AR038

REF OEM 590738

ARRANQUES ADAP. WACKER

ARRANQUE ROBIN EY20 MODERNO



78011055

ARRANQUES ADAP. YANMAR

ARRANQUE YANMAR L40

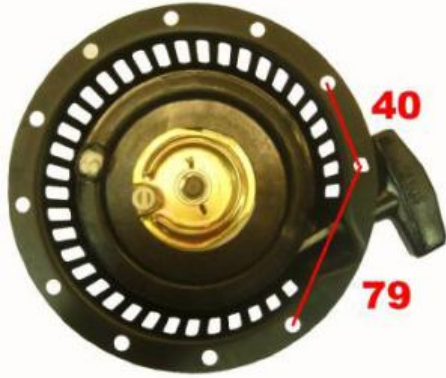

78011051

ARRANQUE YANMAR L60

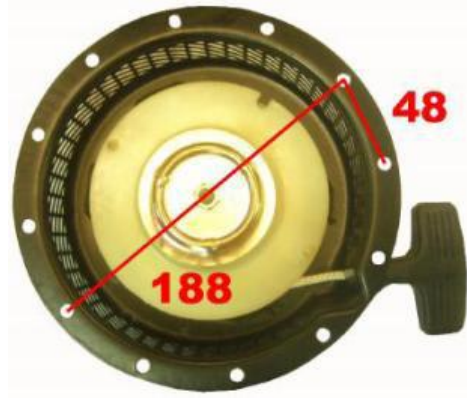

78011052

ARRANQUE COMPL. 170F/LA48/LA-40
2 PATILLAS

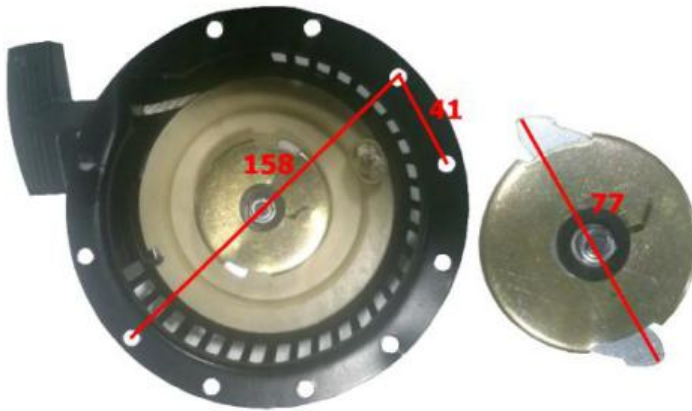

78011053

ARRANQUE COMPL. 178F/LA70/LA-60
2 PATILLAS

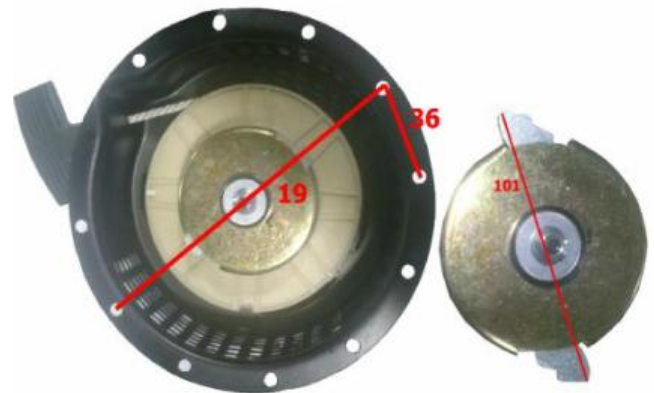

78011054

REF OEM 714880-76820

ARRANQUE COMPLETO 186F/LA100/LA-90

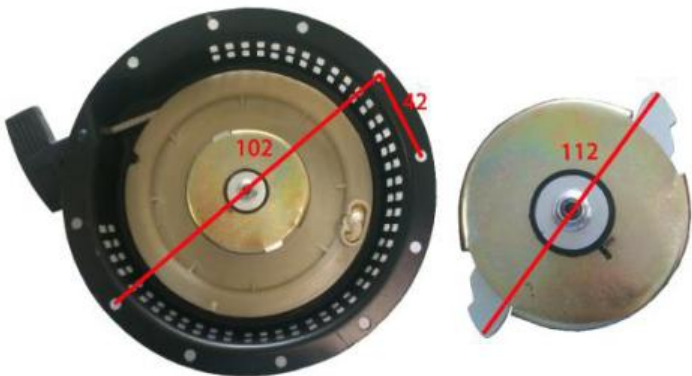

78011056

REF OEM 114650-76250

ARRANQUES ELECTRICOS ADAP. HONDA

PARA GX Y OHV



78030001
78030002
78030003

GX, OHV 140-160
GX, OHV 240-270
GX, OHV 340-390

RELE ARRANQUE



78030006
78030007

GX, OHV 140-160-200
GX, OHV 240-270-390

PARA GX Y OHV



78030004

GX, OHV 620

PARA GX Y OHV



78030005

GX, OHV 670

CLAUSOR COMPLETO



35013X

OHV 160-390

CLAUSOR COMPLETO

35014X

OHV 620-630

ELECTRO VALVULA STARTER AUTOMATICA

78030008

OHV 240-390

ARRANQUES ELECTRICOS ADAP. BRIGSS

MOTOR DE ARRANQUE B&S 16Z

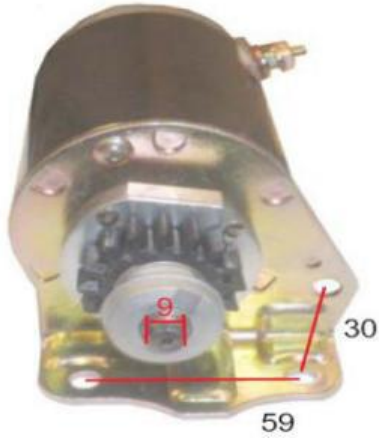

78030023

MOTOR DE ARRANQUE B&S 16Z



78030024

KIT REPARACION ARRANQUE B&S



78030025

BIELAS

BRIGGS & STATTON

3,3-1/2HP, 8B (H)(HA)



BI009

4HP, 110000, 111000



BI010

4HP, 110000, 100000



BI012

8HP, 1904000, 191700, 195400



BI013

5.5HP



BI001

16 HP



BI006

6.5 HP



BI007

10,11 HP, 2514000, 253700



BI008

HONDA

GX-100-152



78014005

OHV 110, 120

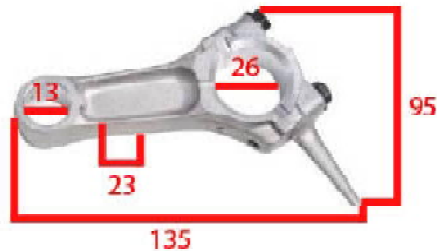

78014000

OHV 140- 160

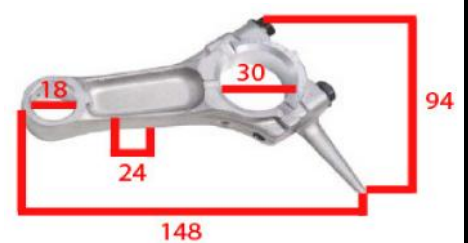

78014001

GXV160



BI014

OHV 200



78522000

OHV 240, 270



78014002

HONDA

GX390 (STD)

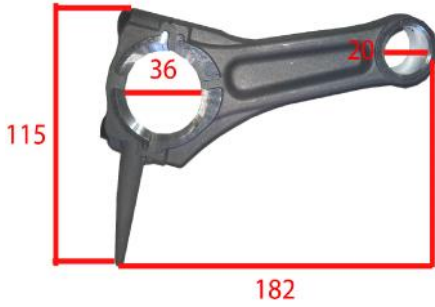

78014003

OHV 620

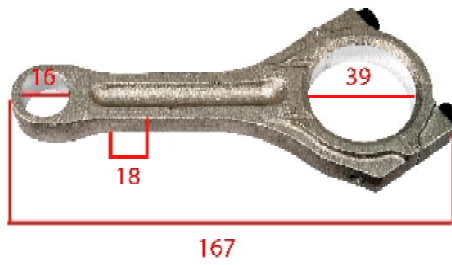

78014004

OHV 160 STD VERTICAL



92MT620/P3/7

OHV 100-152 SOBREMEDIDA 0.25



78491000

OHV 110-120 SOBREMEDIDA 0.25



78612000

OHV 140-160 SOBREMEDIDA 0.25



78014009

OHV 200 SOBREMEDIDA 0.25



78014010

OHV 240-270 SOBREMEDIDA 0.25



78014011

OHV 340-390 SOBREMEDIDA 0.25



78014012

OHV 390 VERTICAL SOBREMEDIDA 0.25



78014013

OHV 160 CORTACESPED



78014014

OHV 080, 090



78013998

GXV160 STD



78013992

H 100



78013996

BOBINA A.T. ADAP. BRIGGS & STRATTON

BRIGGS&STRATON 2-4 HP

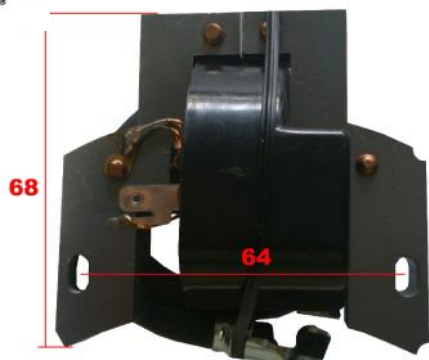

78017030

BRIGGS&STRATON 2-4 HP



78017032

BRIGGS&STRATON 5HP

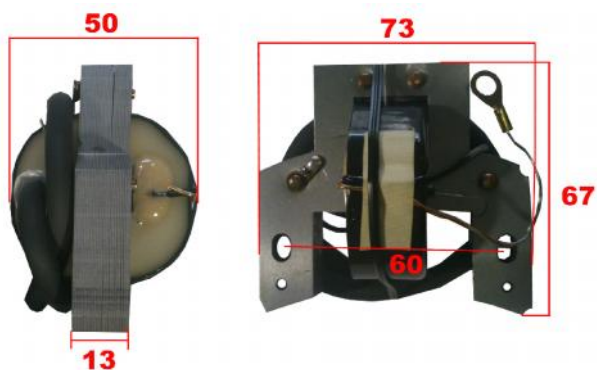

78017034

BRIGGS&STRATON 5HP

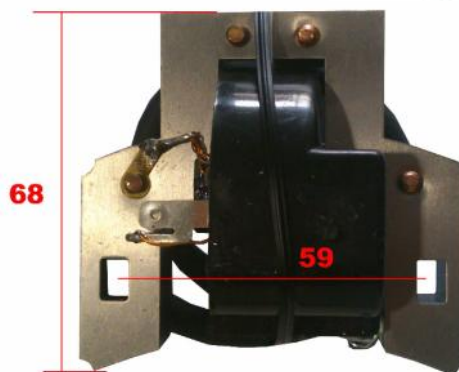

78017036

BRIGGS&STRATON 7-16HP

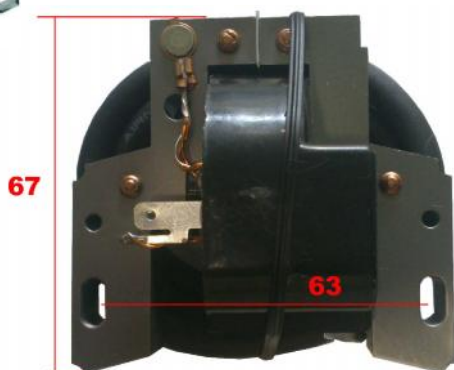

78017038

BRIGGS&STRATON QUANTUM EUROPA



78017040

BRIGGS&STRATON 7-11HP



BO15

BRIGGS&STRATON 10-13HP



BO009

BOBINA A.T. ADAP. BRIGGS & STRATTON

BRIGGS&STRATON 16-18 HP



BO006

BRIGGS&STRATON



BO007

BRIGGS&STRATON 11-12 CID



BO008

BRIGGS&STRATON



BO003

BRIGGS&STRATON



BO004

BOBINA A.T. ADAP. HONDA

PARA OHV Y GX

HONDA



78017000
78017001
78017002

A50
A70

OHV 80-90
OHV 120/ 160/ 200
OHV 270/ 340/ 390

PARA CORTACESPED CABLE

HONDA

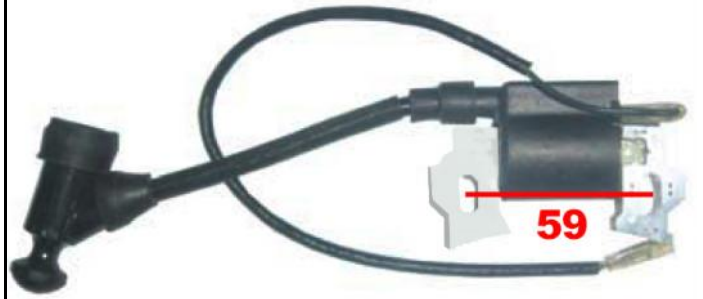

78100005

CABLE 360mm

PARA CORTACESPED CABLE

HONDA

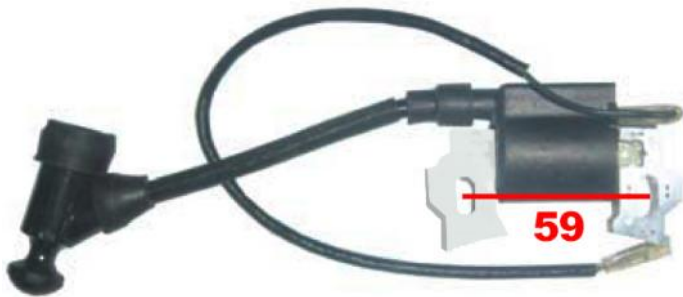

78100006

CABLE 180mm

BOBINA OHV G150-G200

HONDA



78017004

BOBINA OHV H100

HONDA

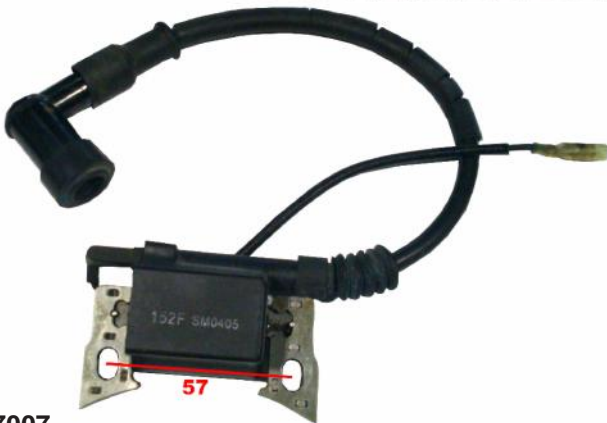

78017007

BOBINA OHV GXV160

HONDA

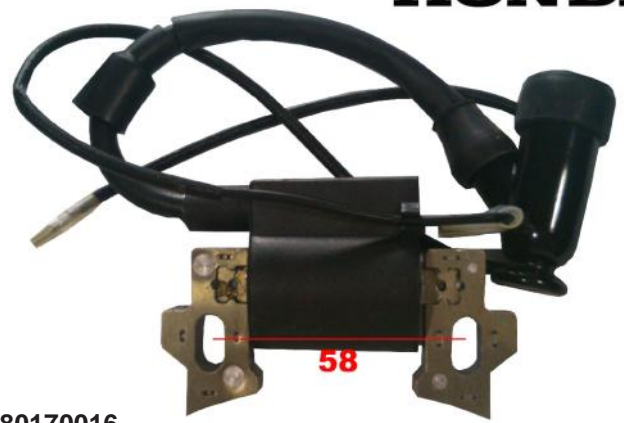

780170016

BOBINA GX-100 (COMPACTADOR)

HONDA



78017014

PIPA BUJIA GX, OHV.

HONDA



78018001

BOBINA A.T. ADAP. HONDA

PARA OHV Y GX 620

HONDA



78017006

BOBINA DERECHA

PARA OHV Y GX 620

HONDA



78017005

BOBINA IZQUIERDA

PARA OHV 140-160 VERTICAL



188260053

HONDA

PARA GCV 135/160



BO018

HONDA

BOBINA A.T. ADAP. HUSQVARNA

BOBINA ARRANQUE 51,55,61,268,272

Husqvarna
SWEDEN



BO020

BOBINA ARRANQUE 365

Husqvarna
SWEDEN



BO021

BOBINA A.T. ADAP. KAWASAKI

BOBINA ARRANQUE AD TD40/43/48 KAZZ



BO022

Kawasaki

32cc & 33cc

BOBINA A.T. MIGARDEN

PARA OHV Y GX 620



78017006

BOBINA DERECHA

PARA OHV Y GX 620



78017005

BOBINA IZQUIERDA

BOBINA DE ARRANQUE MTS-18



508183-2-29

BOBINA ENCENDIDO MTS 40Z



78017022

BOBINA OHV GXV160

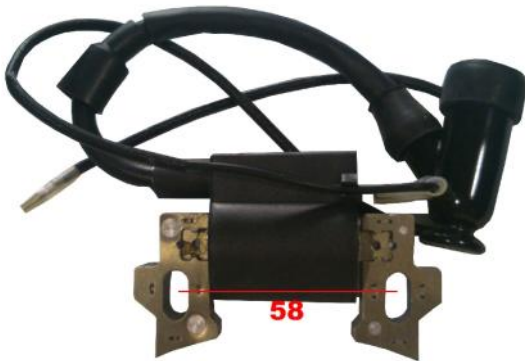

780170016

BOBINA DE ARRANQUE H100

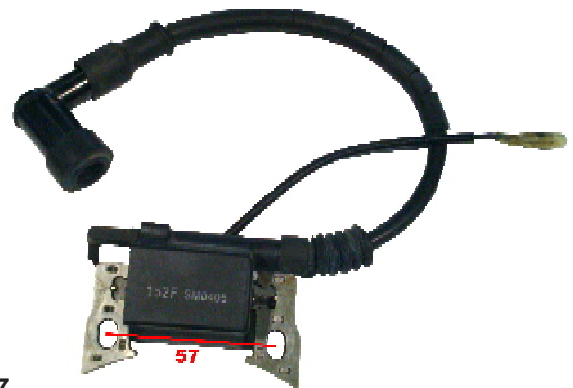

78017007

BOBINA MOTOSIERRA 25cc



040325127

BOBINA MOTOSIERRA 45cc



040345027

Estos articulos no son originales, son adaptables a diferentes marcas.

BOBINA MOTOSIFRA 72cc



0403720-5

BOBINA MOTOR 32cc



2T32-3

BOBINA MOCHILA POLVO



0407420-3

BOBINA KIT MULTICUTTER, MOTOR 2T 25cc



78017080

BOBINA SOPLADOR 63.3 cc

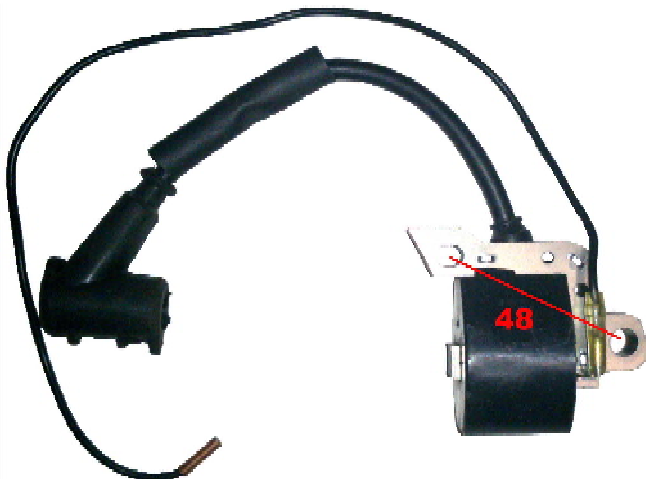

0410630-3

PARA MOTOR DE 42cc Y 51cc

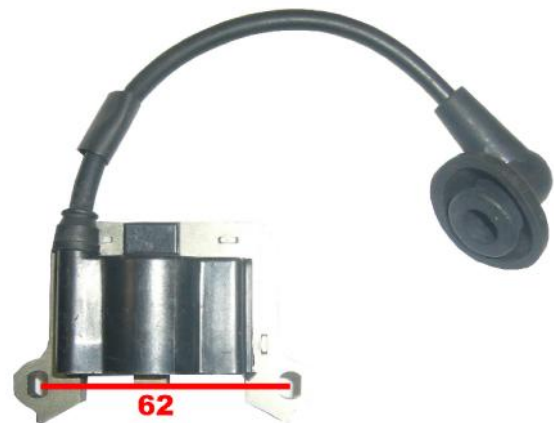

2T42-3

BOBINA DESBROZADORA 0408520



408520156

BOBINA OHV G150-G200



78017004

BOBINA A.T. MI GARDEN



PARA OHV



78017000
78017001
78017002

A50
A70

OHV 80-90
OHV 120/ 160/ 200
OHV 270/ 340/ 390

PARA CORTACESPED CABLE

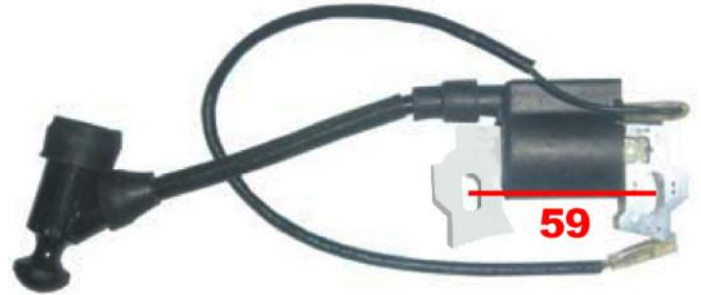

78100005
78100006

CABLE 360mm
CABLE 180mm

BOBINA GX-100 (COMPACTADOR)



78017014

BOBINA OHV 160-200 40cm

78017003

BOBINA OHV 340-390 40cm

78017004

BOBINA OHV 140-160 VERTICAL

78017008

EMBOBINADO MAGNETICO OHV 160



78030010

EMBOBINADO MAGNETICO OHV 270/390



78030011

BOBINA A.T. MI GARDEN



EMBOBINADO MAGNETICO OHV 620



78030013

ALARMA NIVEL ACEITE RECEPTOR OHV080 090

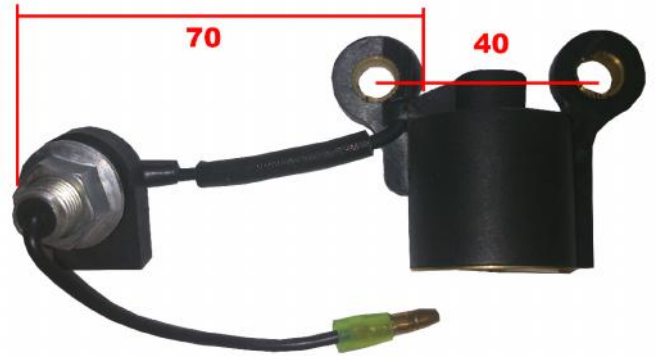

78029000

ALARMA ACEITE OHV 160



78029001

ALARMA ACEITE OHV 270-390



78029002

78030013

DIODO PARE MOTOR OHV 620



78029001

78017010

BOBINA ARRANQUE ROBIN

ROBIN EH025, BL25



78017070

Robin
SUBARU

ROBIN EH075, BL75



78017072

Robin
SUBARU

BOBINA ARRANQUE ROBIN

<p>ROBIN EY15</p>  <p>Robin SUBARU</p> <p>BO025</p>	<p>ROBIN EY20</p>  <p>Robin SUBARU</p> <p>78017074</p>
---	---

<p>ROBIN EY28</p>  <p>Robin SUBARU</p> <p>BO027</p>	
--	--

BOBINA ARRANQUE STIHL

<p>STIHL 024,026,029,034,036,036QS,038,039,044,048,064, FS360, FS420</p>  <p>BO001</p> <p>STIHL[®]</p>	<p>STIHL FS 120, 200, 250, 300, 350 , FR350</p>  <p>78017050</p> <p>STIHL[®]</p>
---	--

<p>STIHL 018,180,MS180</p>  <p>BO002</p> <p>STIHL[®]</p>	
---	--

PIPAS DE BUJIA

CON MUELLE

STIHL®

118680 Ø 5 mm

CON MUELLE

118690 Ø 7 mm

PIPA BUJIA HUSQVARNA

Husqvarna
SWEDEN

78017060

PIPA BUJIA BRIGGS&STRATTON

BRIGGS&STRATTON

78017041

PIPA BUJIA STIHL 026, 036, 038, 044, 046, 066 .

STIHL®

78017052

TIPO HONDA GX 160/270/390

HONDA **miGARDEN**

78018001

BUJIA SIN CASQUILLO

118720 Ø 5 mm

BUJIA SIN CASQUILLO

107060 Ø 7

PIPAS DE BUJIA

TIPO SUPER

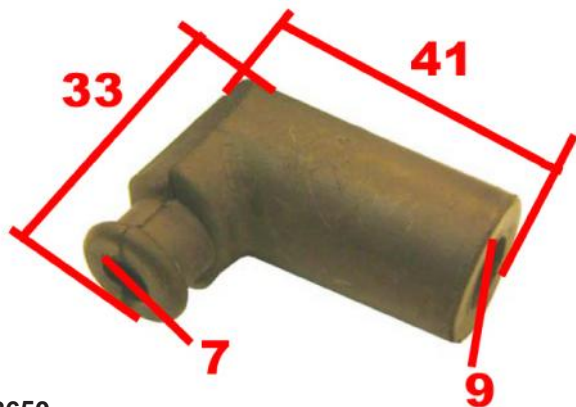

118650

TIPO ESTANDAR

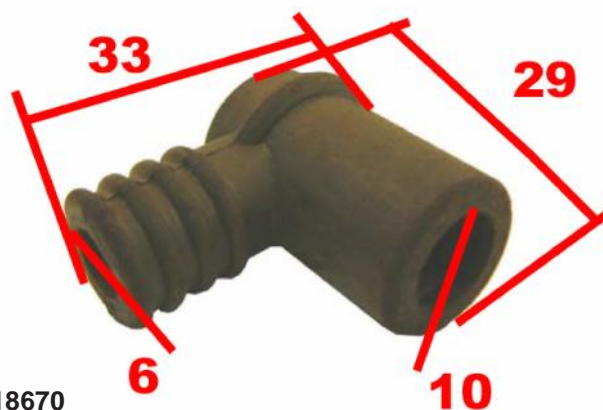

118670

TIPO NGK CON RESISTENCIA



118710

PIPAS DE BUJIA

PEQUEÑA



CUELLO CORTO



REF	NOMBRE ORIGEN	Ø ROSCA	MEDIDA LLAVE	ALTO TOTAL
114880	BM6F	14	16	48
105660	BM6A	14	19	50
105650	BM7A	14	19	50

REF	NOMBRE ORIGEN	Ø ROSCA	MEDIDA LLAVE	ALTO TOTAL
114980	B6HS	14	20	72
115020	B7HS	14	20	72

CUELLO LARGO

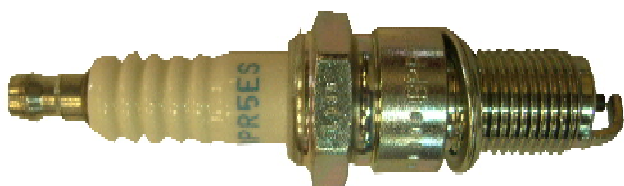

BUJIA MTS18



REF	NOMBRE ORIGEN	Ø ROSCA	MEDIDA LLAVE	ALTO TOTAL
114950	BPR5ES	14	20	80
	BPR6ES	14	20	80

REF	Ø ROSCA	MEDIDA LLAVE	ALTO TOTAL
508183-2-36	10	16	51

REF	NOMBRE ORIGEN	Ø ROSCA	MEDIDA LLAVE	ALTO TOTAL
126270	CMR7H	10	16	

BOMBA ACEITE ALPINA

ALPINA CP270



124470

P 360 370 390 410 (D,8 .)



126310

360,370,390,410 (D9)



126311

BOMBA ACEITE ECHO

302-304-315-330-351-360- 400-440-452-500-
550-650-650 2°SERIE-660



124400

BOMBA ACEITE OLEOMAQ ECHO



124460

BOMBA ACEITE HUSQVARNA

36-41-136-141



124410

40-45



124420

50-51-55

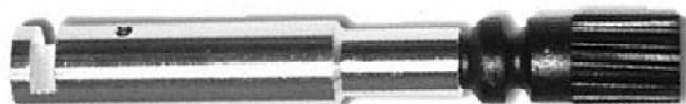

124430

365,371,372



124432

340,345,350



124431

BOMBA ACEITE JONSERED

2036-2040



124410

2041-2045-2050



124420

BOMBA ACEITE MIGARDEN

MOTOSIERRA 25 cc



124470

MOTOSIERRA 45 cc

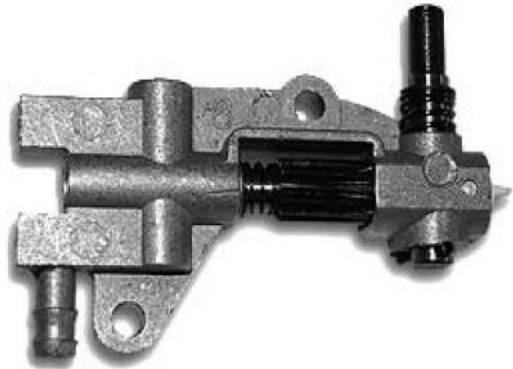

124480

MOTOSIERRA PODA 18CC



508183-2-1

MOTOSIERRA 72CC



0403720-12

BOMBA ACEITE OLEOMAC

251-261-252-254-350-Agristar-355



124440

240-233



124450

935



124460

BOMBA ACEITE STHIL

024026MS240260



MS 170 180 210 230 250



126320

126321

066



046 MS 460



126322

126323

036 MS 360



126324

BOMBA ACEITE ZENOAH

G250-2500



124470

415-455-500

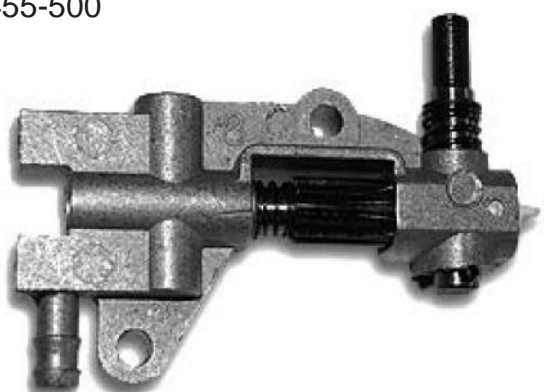

124480

BOMBA GASOLINA KAWASAKI



78005022

BOMBA GASOLINA MIKUNI

DK-44K



78005024

BOMBA GASOLINA UNIVERSAL

B&S, HONDA ,KAWASAKI, KOLER



78005020

BOMBA GASOLINA UNIVERSAL

BOMBA INYECTORA GASOIL 170F/LA48

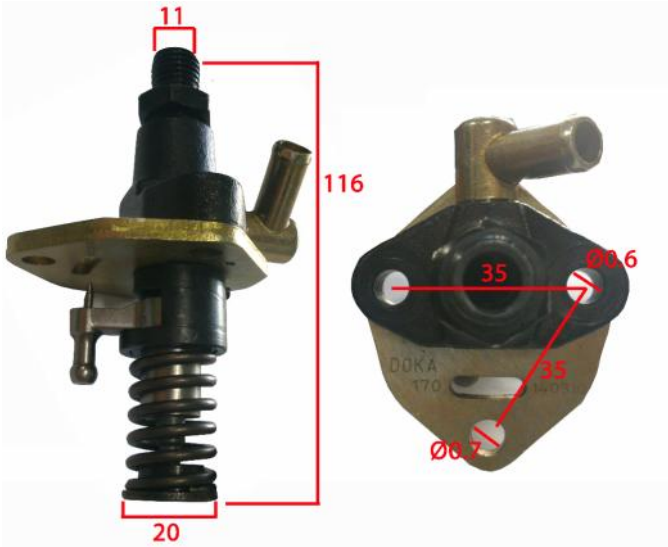

78005040

BOMBA INYECTORA GASOIL 178F/LA70

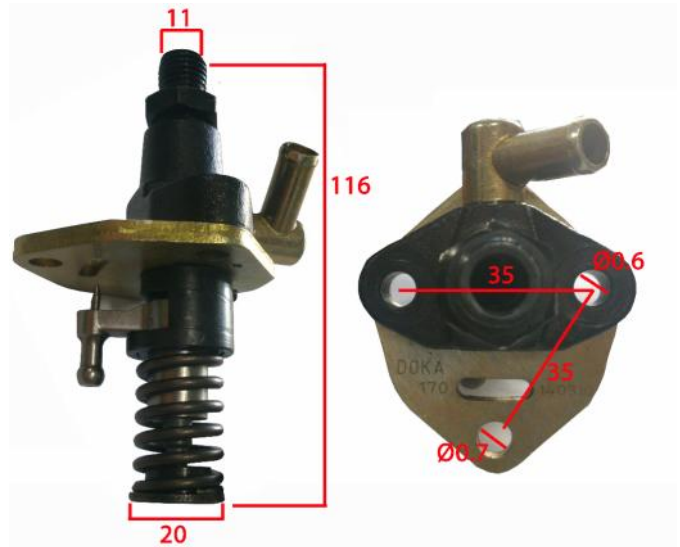

78005042

BOMBA INYECTORA GASOIL 186F/LA100

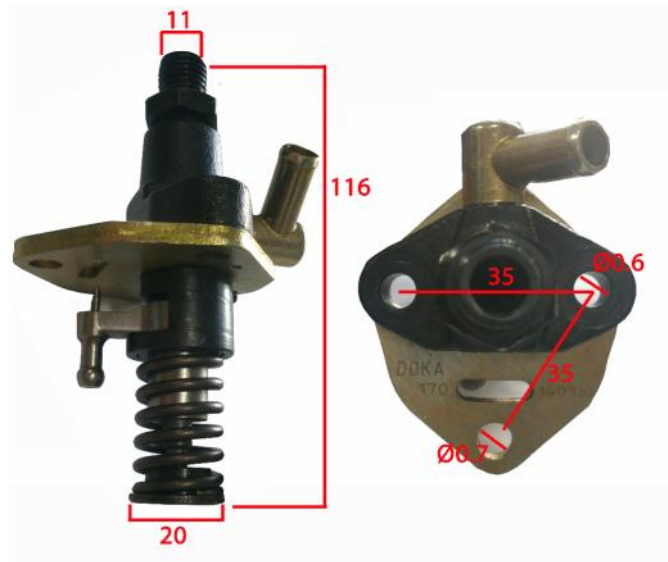

78005044

INYECTOR 170F/LA40, 178F/LA48



78005040

INYECTOR 186F/LA100, LA-90, LA-75

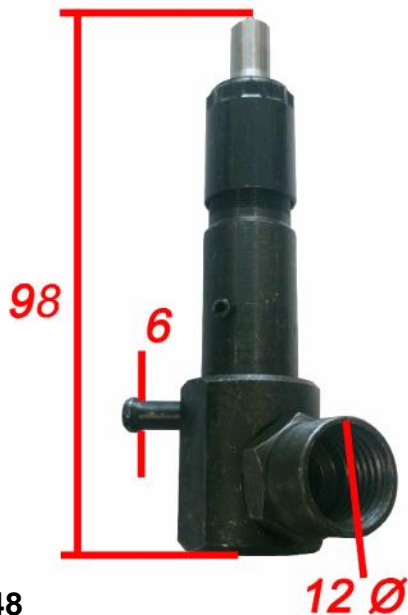

78005048

LIMPIADOR ULTRASONIDOS

MAQUINA ULTRASONIDOS 3 L



78008100 MEDIDAS INTERIOR (238x138x100)

MAQUINA ULTRASONIDOS 6 L



78008102 MEDIDAS INTERIOR (352X152X150)

MAQUINA ULTRASONIDOS 10 L



78008104 MEDIDAS INTERIOR(298X239X150)

MAQUINA ULTRASONIDOS 28 L



78008104 MEDIDAS INTERIOR 498X296X200

DESENGRASANTE ULTRASONIDOS 1 LITRO



78008108

POTENCIADOR ULTRASONIDOS 1 LITRO



78008110

CARBURADORES ADAP. ALPINA



ALPINA VIP-52

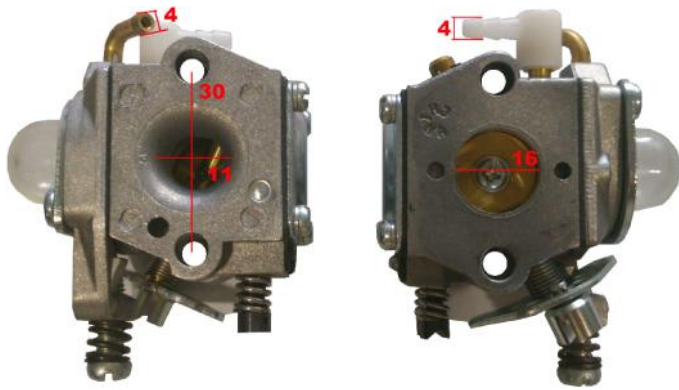

78008045

ALPINA 34, 40, 42

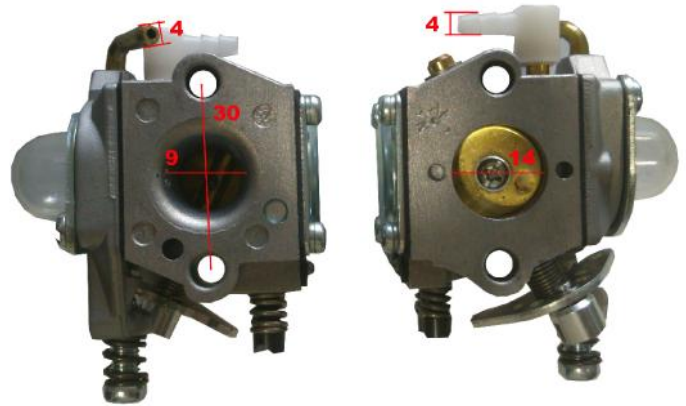

78008047

CARBURADORES ADAP. B&S



CARBURADOR B&S 3



78008021

REF.ORIGINAL: 498170

CARBURADOR B&S 3,5 HP

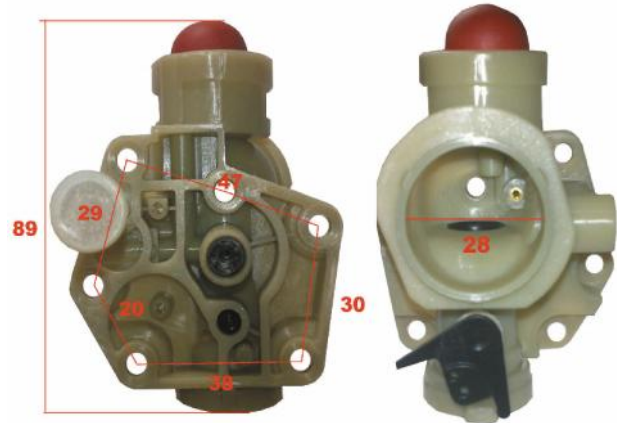

78008022

REF.ORIGINAL: 498809,795469

CARBURADOR B&S 5 HP



78008023

CARBURADOR B&S 9 HP



78008024

CARBURADORES ADAP. B&S



CARBURADOR B&S 10 HP

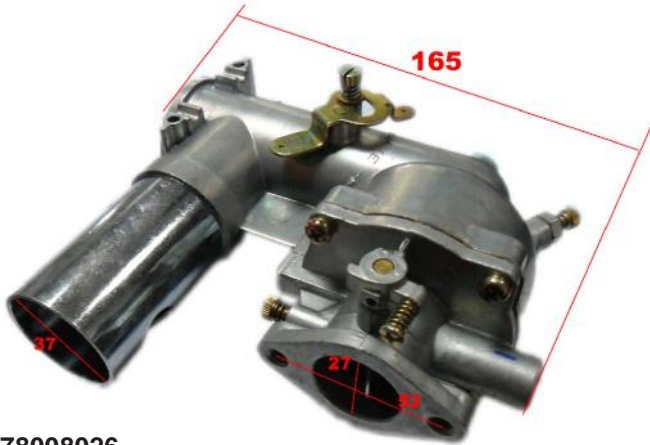

78008026

CARBURADOR B&S 13-16 HP



78008025

REF.ORIGINAL: 391065

CARBURADOR B&S CPL G3

CAR039

CARBURADOR B&S CPL G5

CAR040

CARBURADOR B&S CPL 13HP

CAR035

KIT REPARACION



78008027

KIT REPARACION



78008028

KIT REPARACION



78008029

CARBURADORES ADAP. HONDA

HONDA

CARBURADOR GX 100

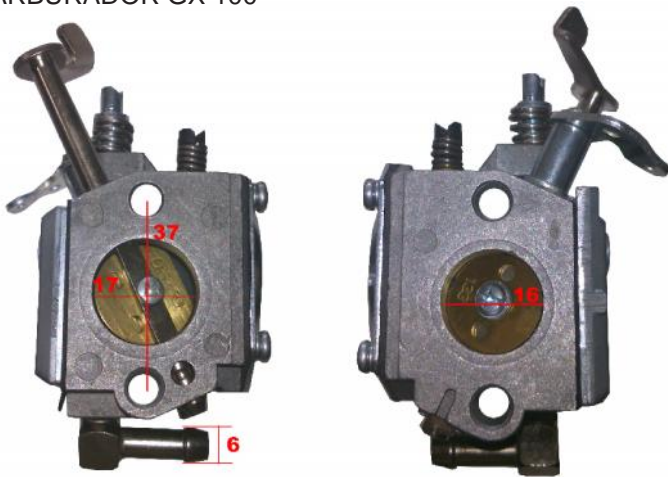

78008011

CARBURADOR GX35



78007994

REF.ORIGINAL: 16100-ZOZ-814

GX120

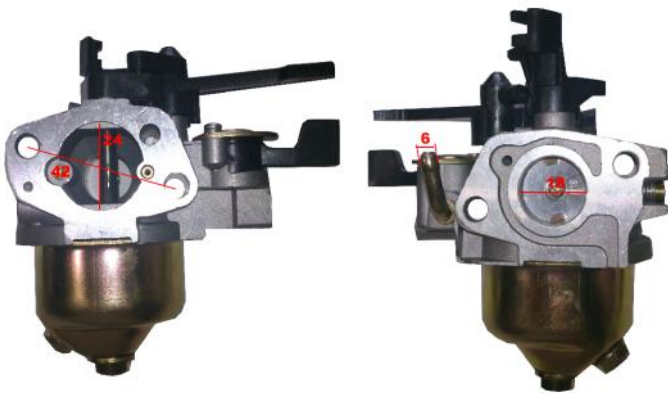

78008004

REF.ORIGINAL: 16100-ZH7-W81

OHV 80-90

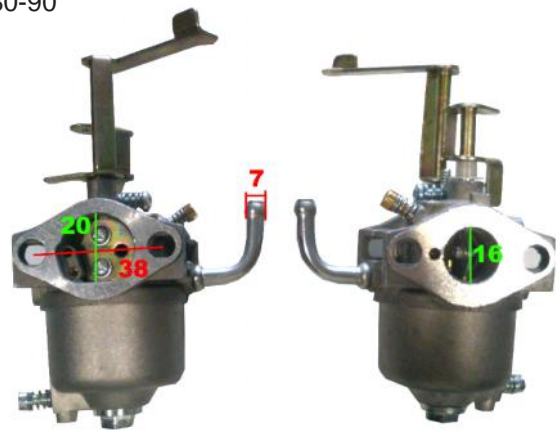

78008000

GX 160

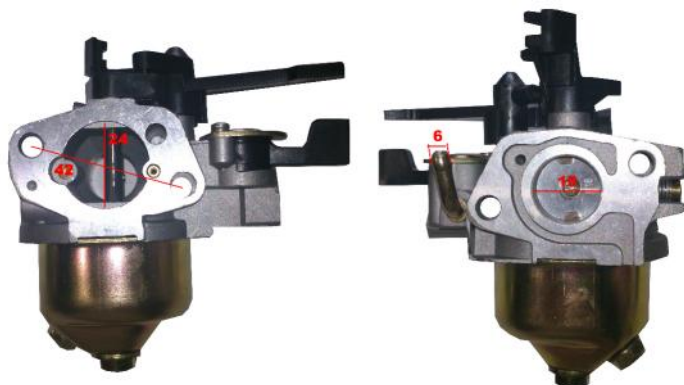

78008001

REF.ORIGINAL: 16100-ZH8-W41

GX 200



78008005

REF.ORIGINAL: 16100-ZLO-W51

GX 270



78008002

REF.ORIGINAL: 16100-ZH9-820

GX 390

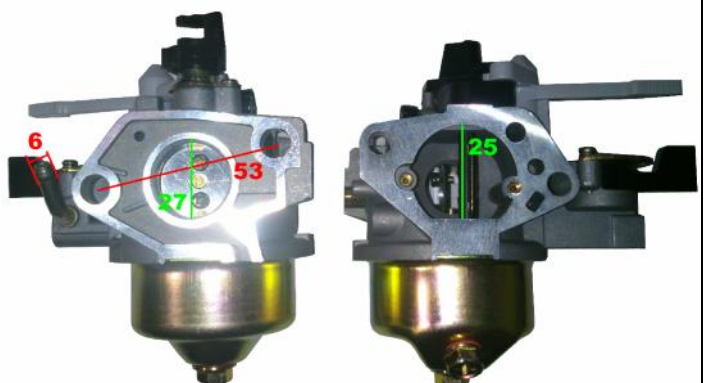

78008003

REF.ORIGINAL: 16100-ZF6-V01

CARBURADORES ADAP. HONDA

HONDA

CARBURADOR GX 620

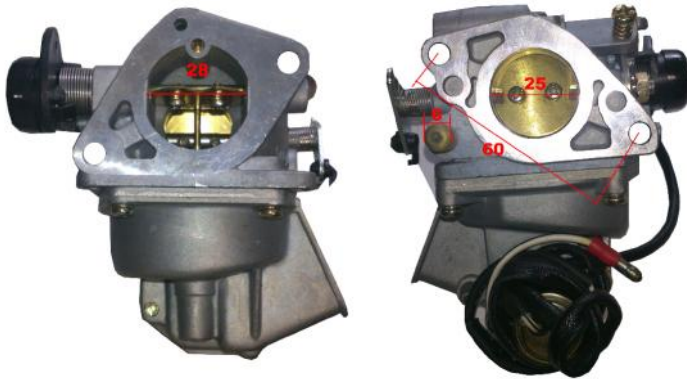

78008010

CARBURADOR GEN720

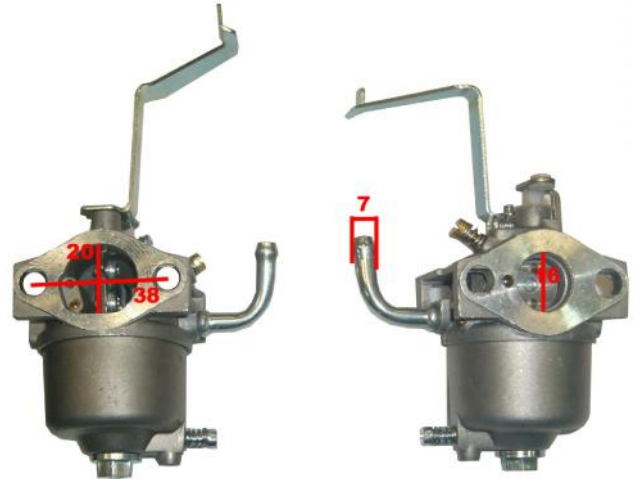

78080092

GENERADOR 2500-2500C SIN GRIFO

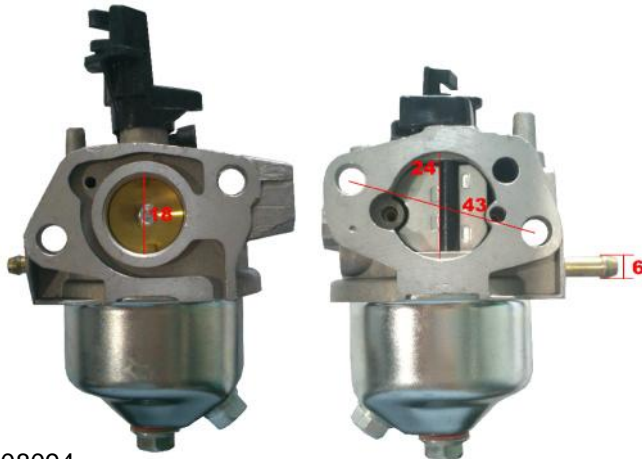

78008094

GXV120

78008019

GXV160

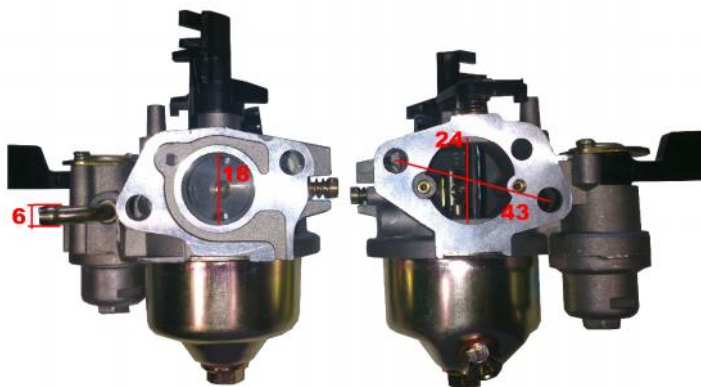

78008018

REF.ORIGINAL: 16100-ZE7-W21

CARBURADOR GCV160



78008007

CARBURADOR G100

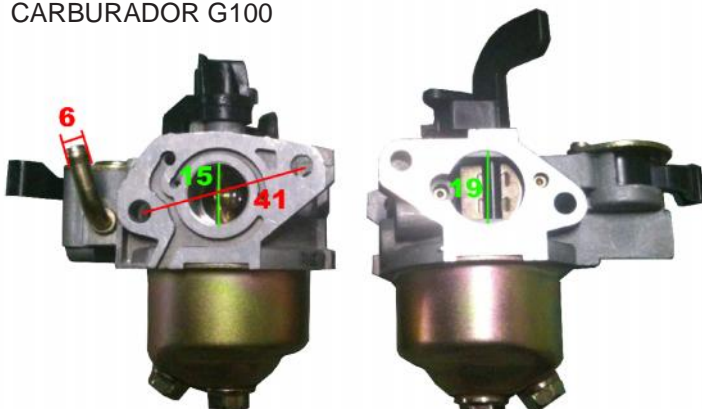

78008009

REF.ORIGINAL: 16100-Z4E-003

CARBURADOR OHV G150



78008006

CARBURADORES ADAP. HONDA

HONDA

CARBURADOR CORTACESPED



78008008

OHV 240 CON SOLENOIDE



78008093

CARBURADOR CPL GX22/31



CAR005

REF.ORIGINAL: 16100-ZM3-803

CARBURADOR CPL G200



CAR004

REF.ORIGINAL: 16100-883-105

CARBURADOR OHV 340



78070000

REF.ORIGINAL: 16110-ZE3-VO1

OHV 270 CON SOLENOIDE



78008095

OHV 340 CON SOLENOIDE

78008097

GENERADOR 6500 (13CV.)



78008096

CARBURADORES ADAP. HONDA

HONDA

GENERADOR 6500 (13CV.) TRIFASICO Y MOTOSOLDADOR



78008098

CARBURADOR GENERADOR 8500 (OHV 440)

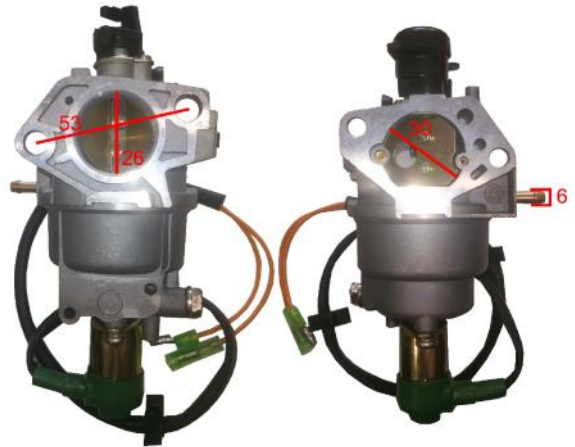

78008099

KIT REPARACION CARBURADOR



78008013
78008015
78008017

OHV 160
OHV 270
OHV 390

AGUJA CARBURADOR



78121000
78121004
78121008

OHV100-152
OHV110-140-160
OHV 240-270-390

AGUJA CARBURADOR PUNTA METALICA



78121006

OHV110-140-160

TOMA CARBURADOR



78018005

OHV80-90

TOMA DE ADMISION



78008055

GXV160

TOMA DE ADMISION

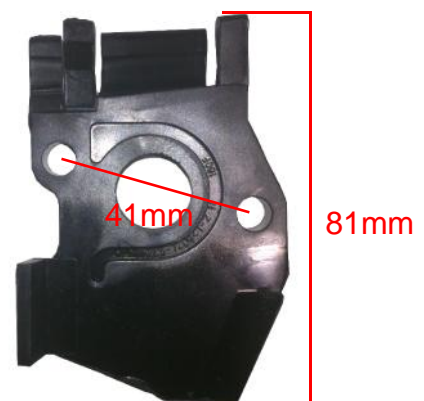

78008050

OHV120

CARBURADORES ADAP. HONDA

HONDA

TOMA DE ADMISION



78008051

OHV160

TOMA DE ADMISION

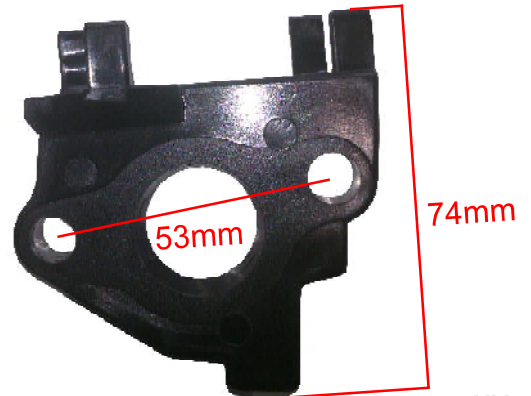

78008052

OHV270

TOMA DE ADMISION



78008053

OHV390

TOMA DE ADMISION CON TOMA DE ASPIRACION



78008054

OHV390

CARBURADORES ADAP. HUSQVARNA

136, 137, 141, 142



78008062

345, 350

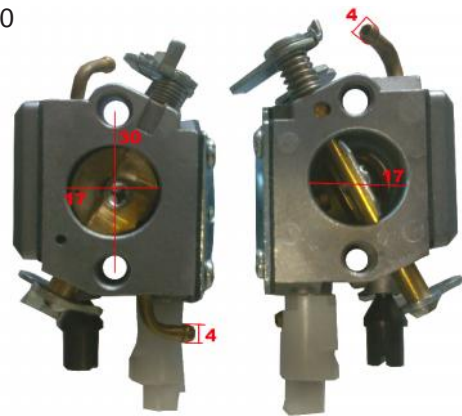

78008078

365, 372

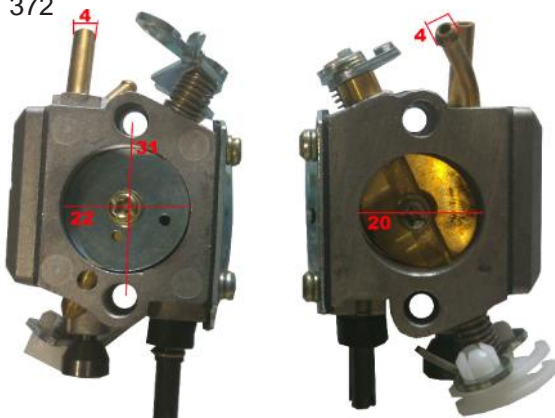

78008066

REF.ORIGINAL: 503283201

61, 268



78008060

REF.ORIGINAL: 503280316

CARBURADORES ADAP. HUSQVARNA

288

CAR027

CARBURADORES ADAP. KAWASAKI

MOTOR 25 cc

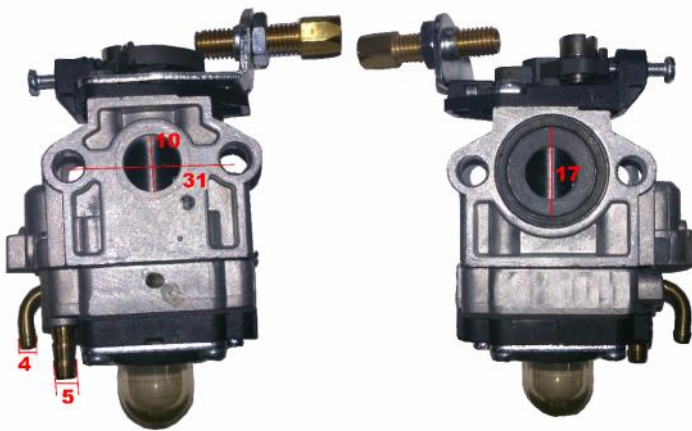

78008068

MOTOR 25cc CON TORNILLO REGULACION

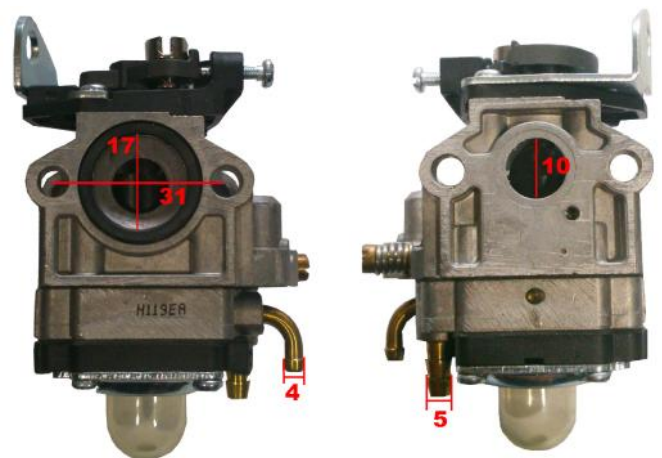

78008069

MOTOR 32 cc

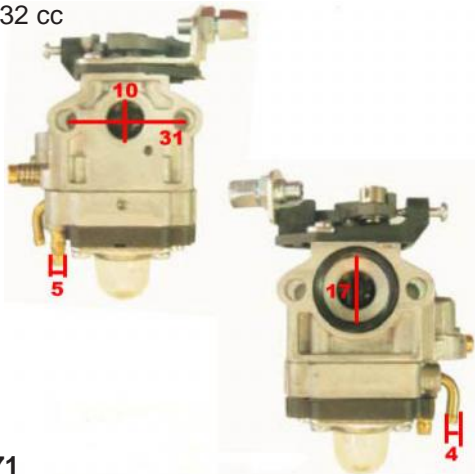

78008071

CARBURADOR COMPLETO MOTOR 42 cc



78008072

DESBROZADORA 0408520

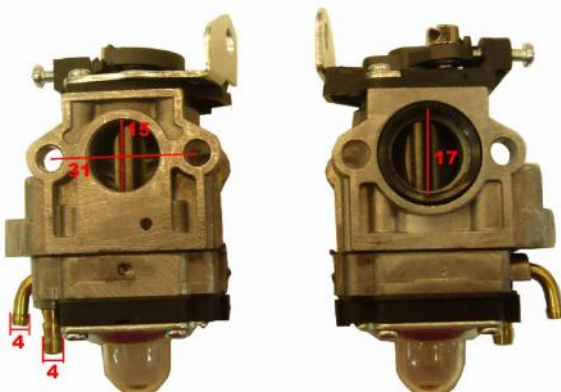

408520167

CARBURADOR COMPLETO
SOPLADOR 63.3 cc Y MOTOR 51 cc

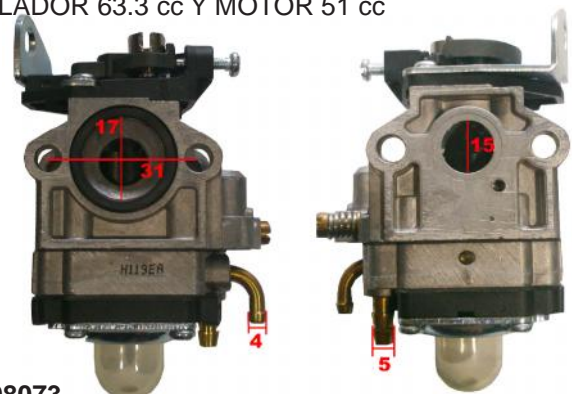

78008073

CARBURADORES KAWASAKI

Kawasaki

FE170, XG450, XG500



78008074

TD40

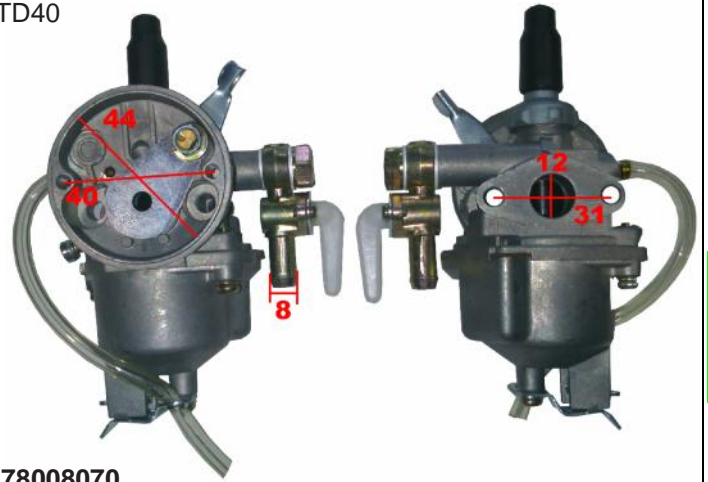

78008070

CARBURADORES MIGARDEN

MOTOSIERRA MTS18

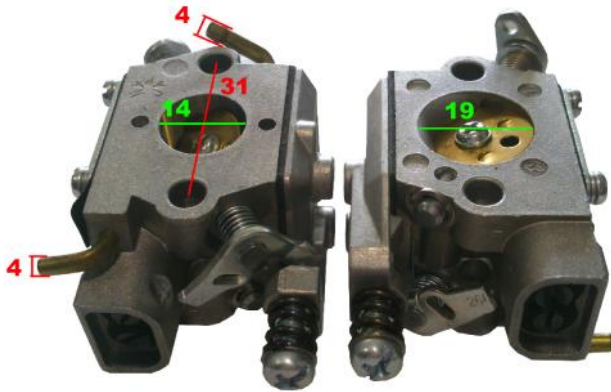

78008040

MOTOSIERRAS DE 25cc

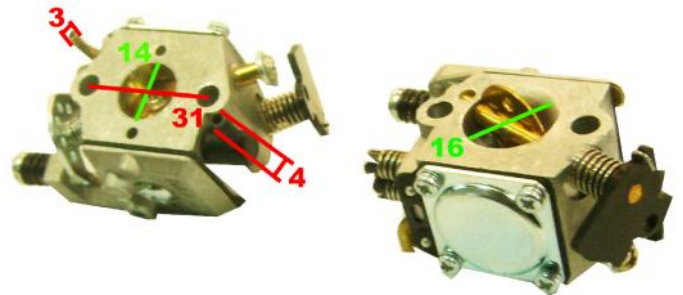

040325126

MOTOSIERRAS DE 45cc

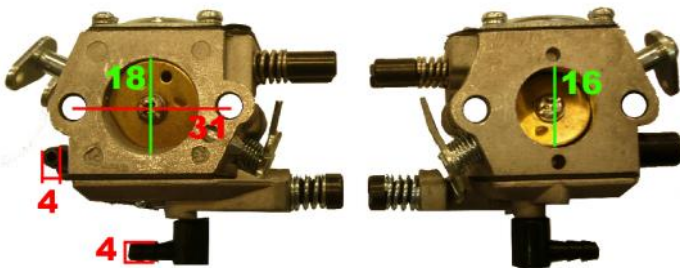

040345061

MOTOSIERRA MTS-40Z

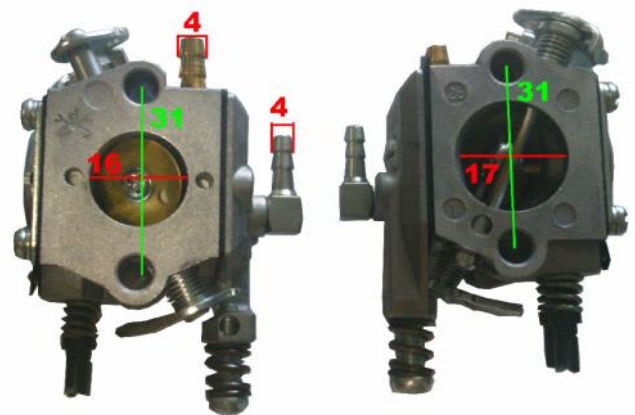

78008042

MOTOSIERRA MT46Z

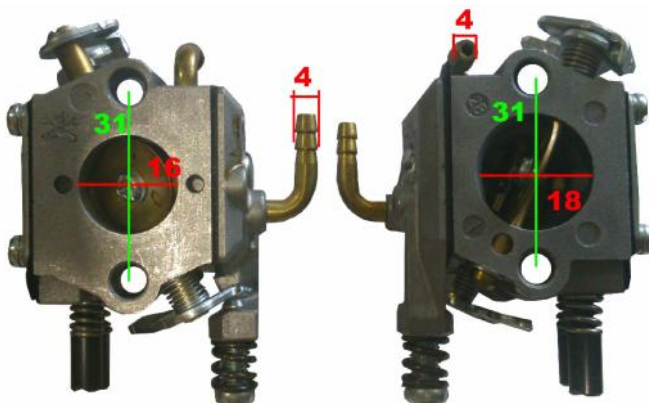

78008044

MOTOSIERRA MT50Z

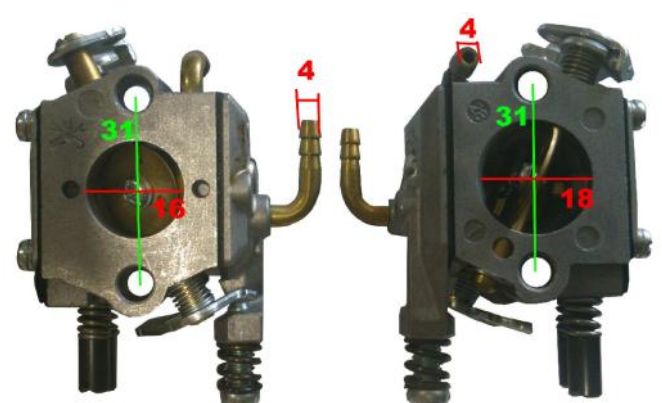

78008046

CARBURADORES MIGARDEN



MOTOSIERRA MT54Z

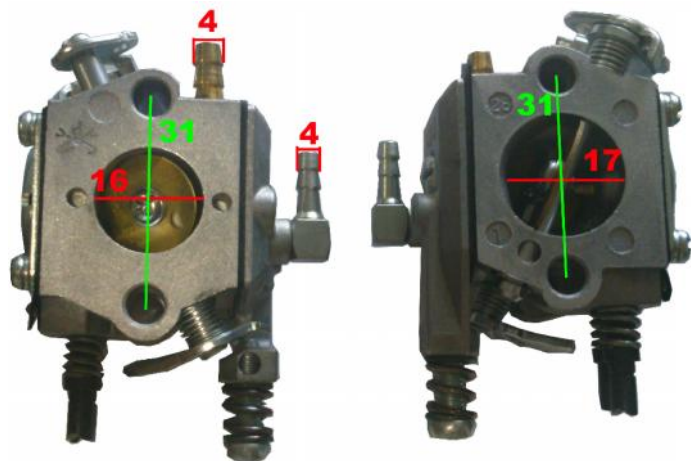

78008048

CARBURADOR DESBROZADORA 49cc

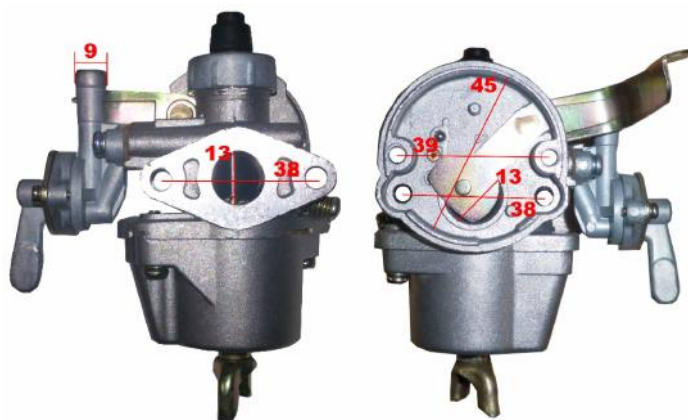

0408490-2

MOTOR 25 cc SIN TORNILLO DE REGULACION

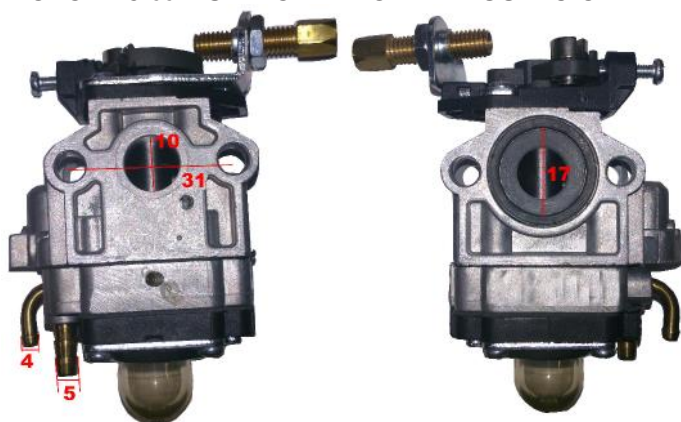

78008068

MOTOR 25cc CON TORNILLO REGULACION

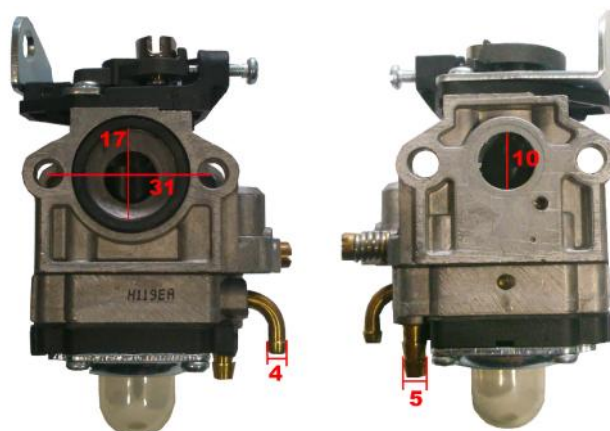

78008069

MOTOR 32 cc

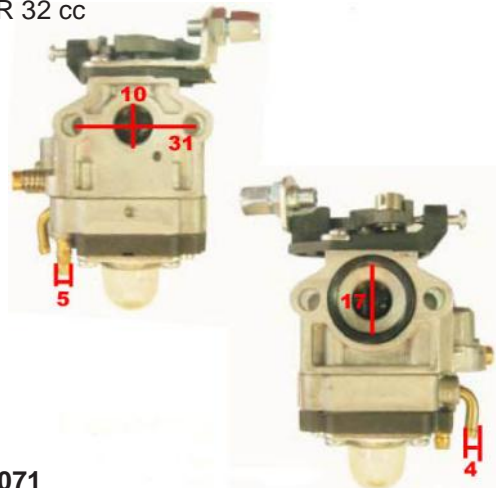

78008071

CARBURADOR COMPLETO MOTOR 42 cc



78008072

DESBROZADORA 0408520

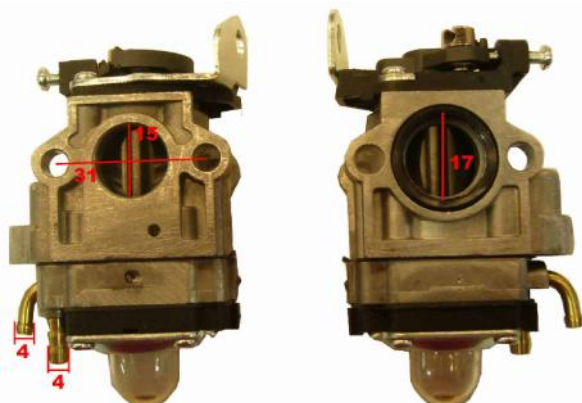

408520167

CARBURADOR COMPLETO SOPLADOR 63.3 cc Y MOTOR 51 cc

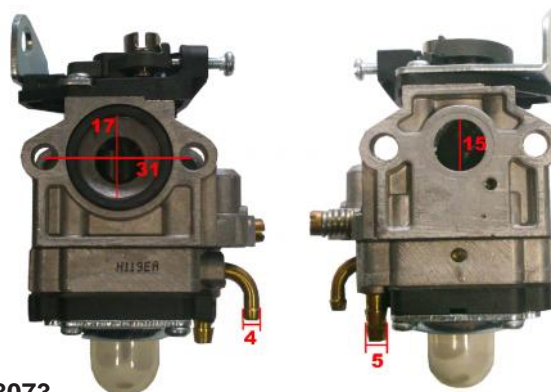

78008073

CARBURADORES MIGARDEN



CARBURADOR H100

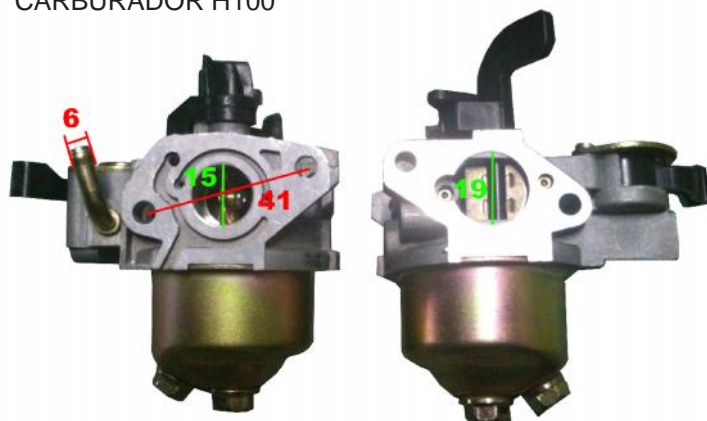

78008009

OHV 80-90

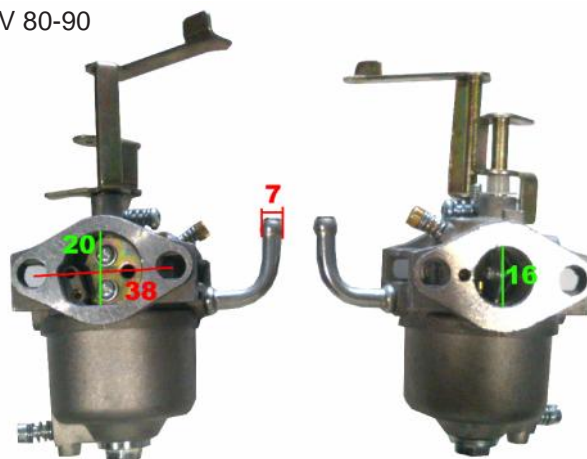

78008000

GX120

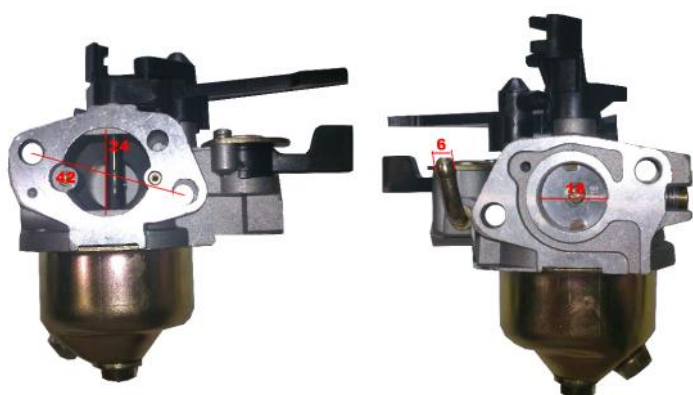

78008004

OHV 160

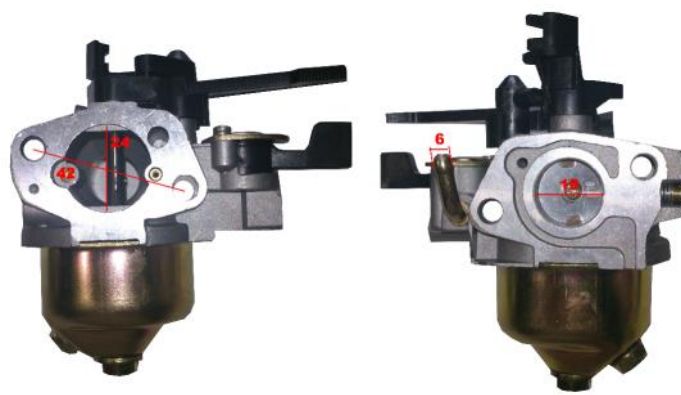

78008001

OHV 200

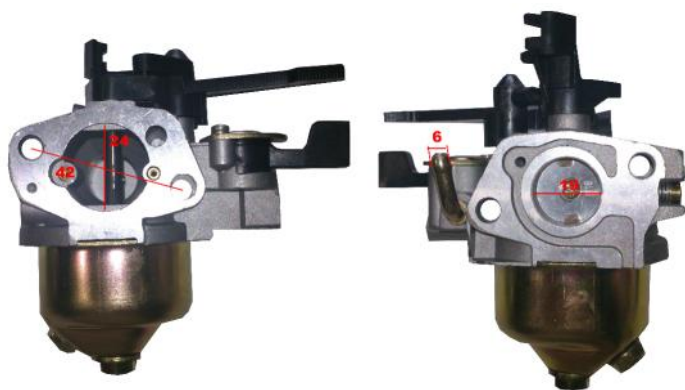

78008005

OHV 270



78008002

OHV 390

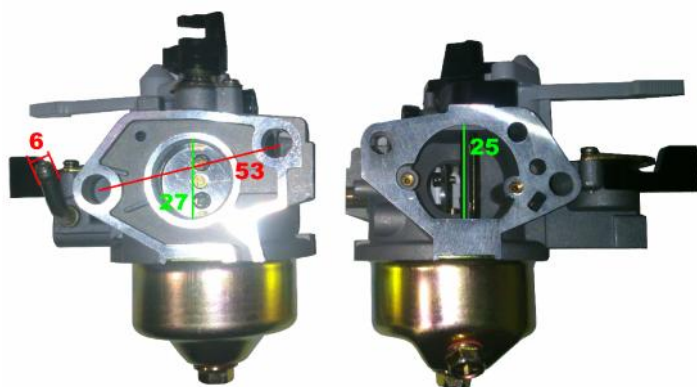

78008003

OHV 620

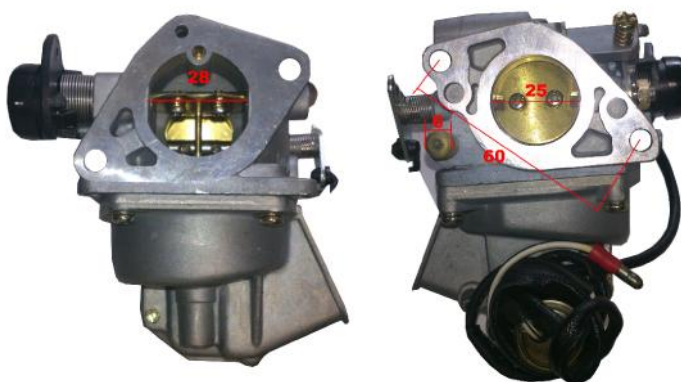

78008010

CARBURADORES MIGARDEN



GEN720

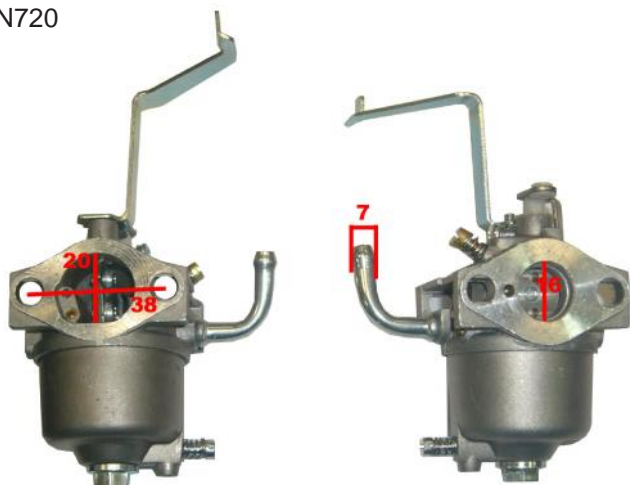

78080092

GENERADOR 2500-2500C SIN GRIFO



78008094

GENERADOR 6500 (13CV.)



78008096

GENERADOR 6500 (13CV.) TRIFASICO Y MOTOSOLDADOR



78008098

OHV 240 CON SOLENOIDE



78008093

OHV 270 CON SOLENOIDE



78008095

OHV 340 CON SOLENOIDE

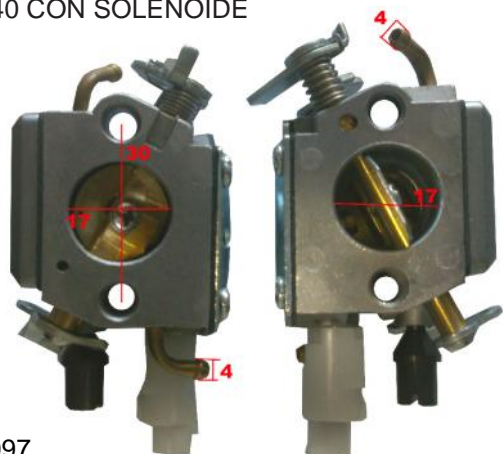

78008097

CARBURADOR MT-33



509002-3

CARBURADORES MIGARDEN



GEN 8500 (OHV 440)



78008099

CARBURADORES ADAP. MITSUBISHI



GT-241

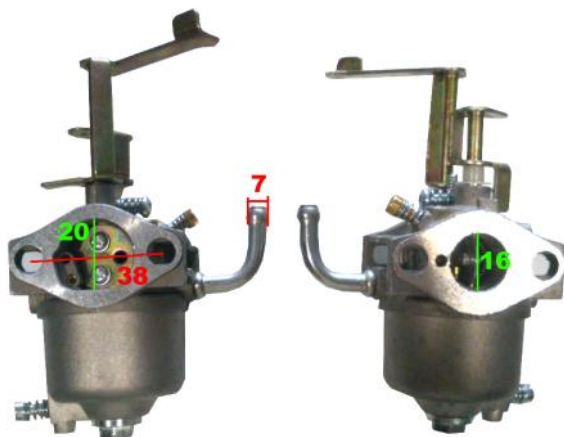

78008000

CARBURADORES ADAP. ROBIN



CARBURADOR ROBIN EY15



78008030

CARBURADOR ROBIN EY18

CAR009

REF.ORIGINAL: 214-62401-10

CARBURADOR ROBIN EY20



78008032

REF.ORIGINAL: 227-62333-00

CARBURADOR ROBIN EY28

CAR031

CARBURADORES ADAP. ROBIN

CARBURADOR ROBIN EC10

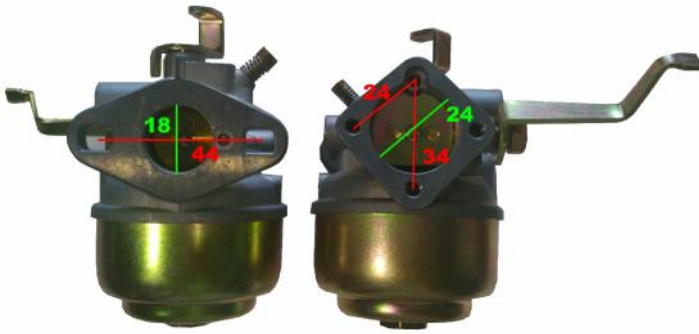

78008031

CARBURADOR ROBIN EH17



78008034

CARBURADORES ADAP. STIHL



017, 018, 170, 180

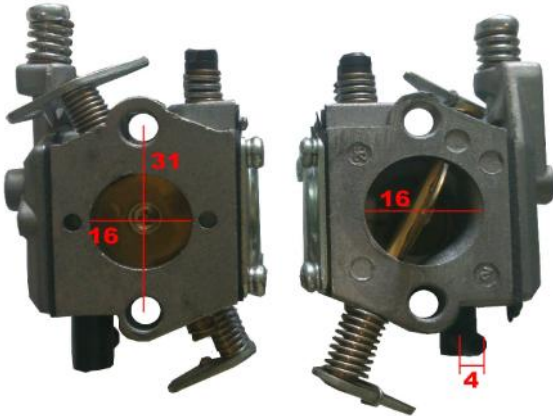

78008080

REF.ORIGINAL: 1130-120-0601

021, 023, 25, 210, 230, 250 .

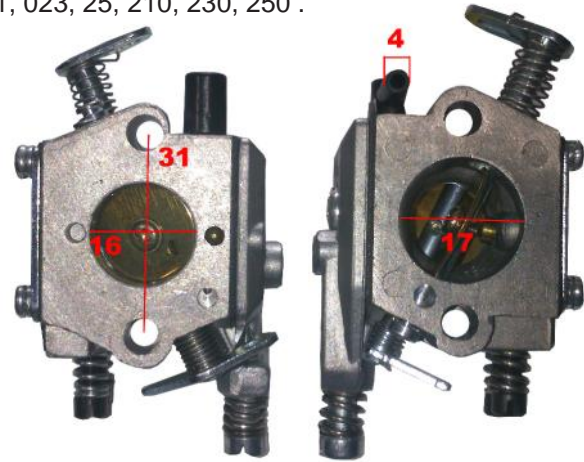

78008082

REF.ORIGINAL: 1123-120-0605

038, 281, 380.



78008084

REF.ORIGINAL: 1119-120-0601

FS120, 200, 250, 300,350

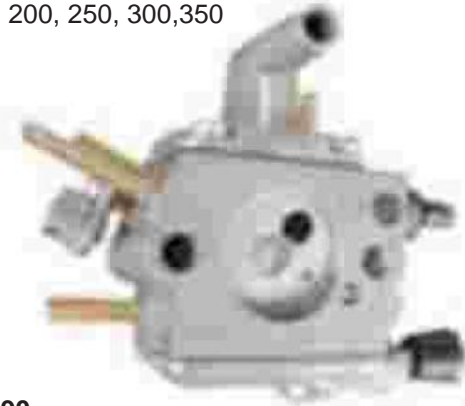

78008090

230



78008086

BR400

78008089

CARBURADORES ADAP. STIHL



FS220/280	FS290
CAR015 REF.ORIGINAL: 4119-120-0602	CAR016 REF.ORIGINAL: 1127-120-0650
FS450	050,051
CAR017 REF.ORIGINAL: 4128-120-0651	CAR012 REF.ORIGINAL: 1111-120-0608
066	MS250
CAR013 REF.ORIGINAL: 1122-120-0618	CAR019 REF.ORIGINAL: 1123-120-0607
MS260	TS400/460
CAR020 REF.ORIGINAL: 260	CAR042 REF.ORIGINAL: 4221-123-7501

CARBURADORES ADAP. WACKER



CARBURADOR WACKER BS-60



78008039

CARBURADORES ADAP. WALBRO

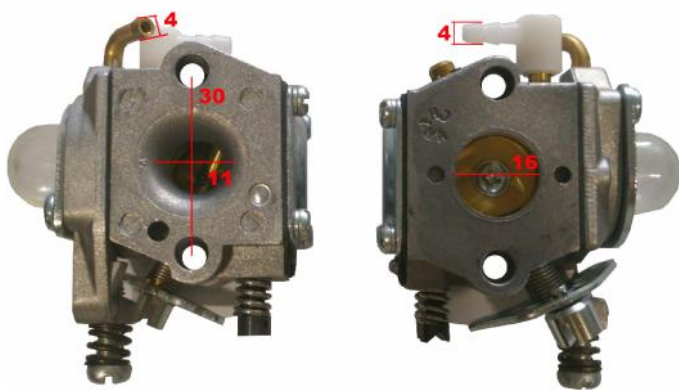

78008045

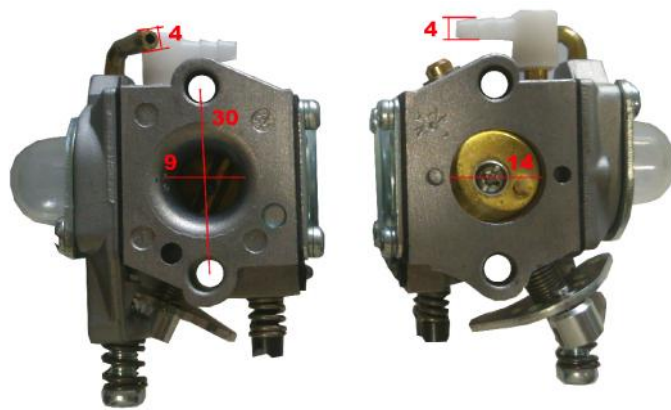

78008047

18cc (WALBRO)

40cc (WALBRO)

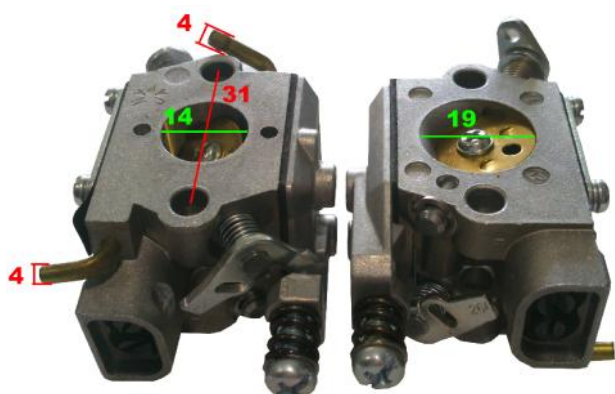

78008040

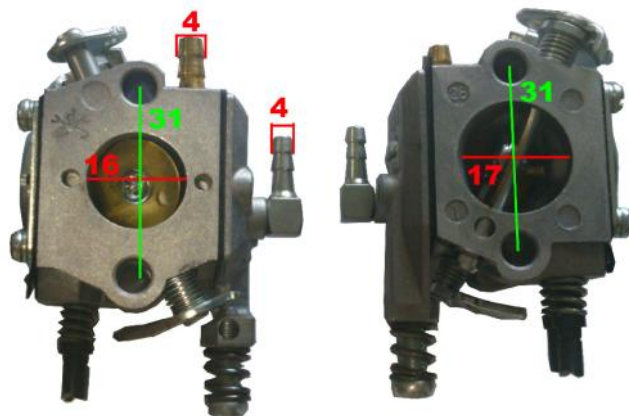

78008042

CARBURADORES ADAP. WALBRO

46cc (WALBRO)

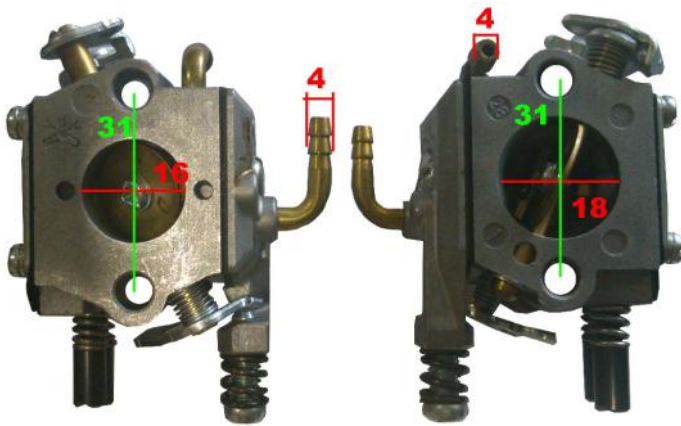

78008044

50cc (WALBRO)

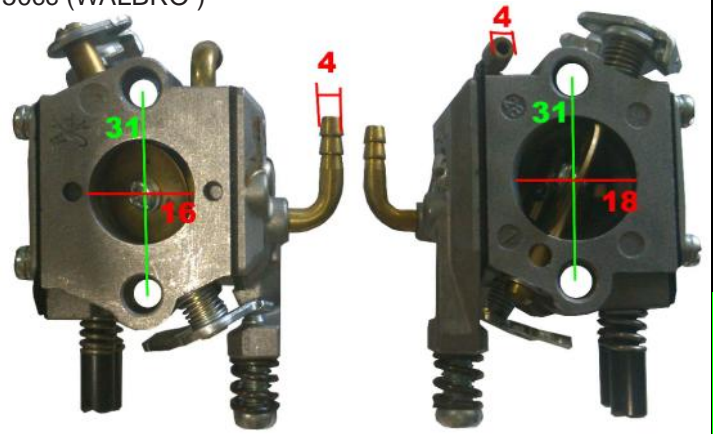

78008046

54cc (WALBRO)

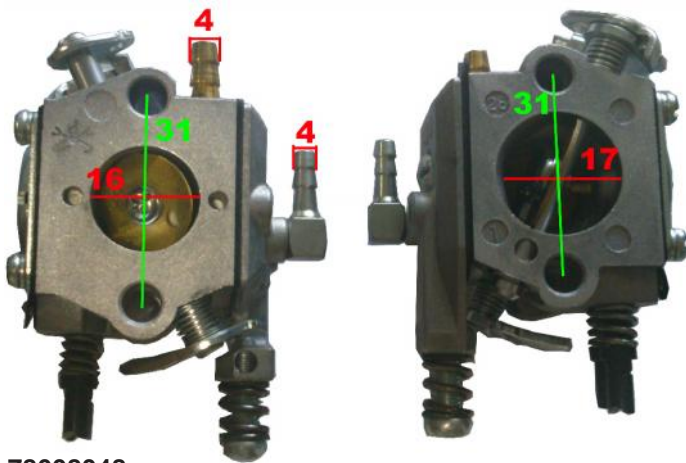

78008048

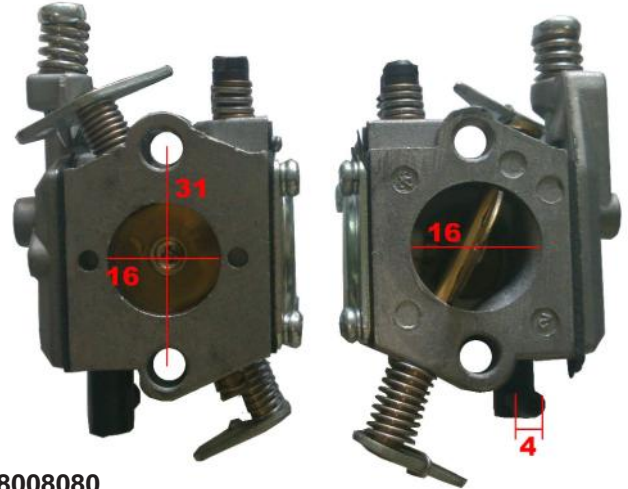

78008080

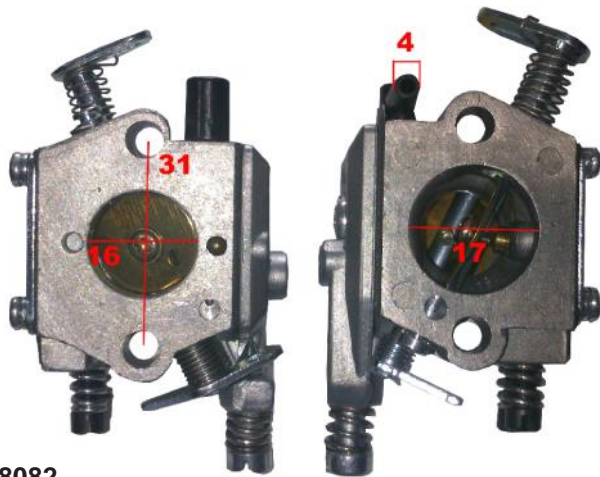

78008082

CARBURADORES ADAP. ZENOHA

45 cc

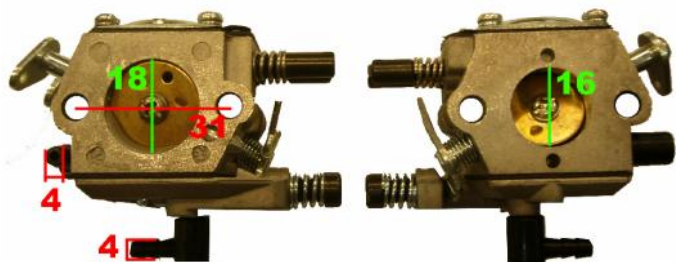

040345061

38 cc



78000834

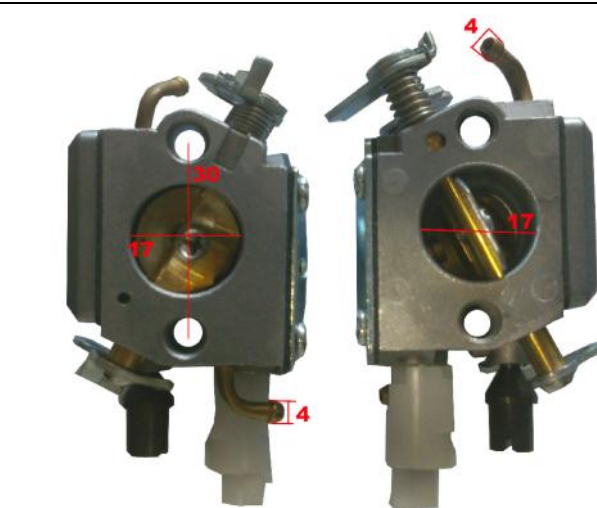

78008078

MOTOR 32 cc



78008071

CEBADORES ADAP. BRIGGS&STRATON

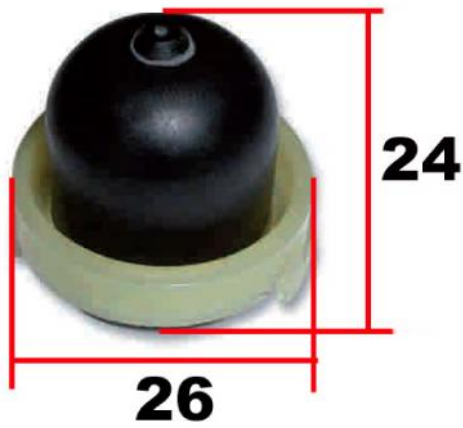

78040000

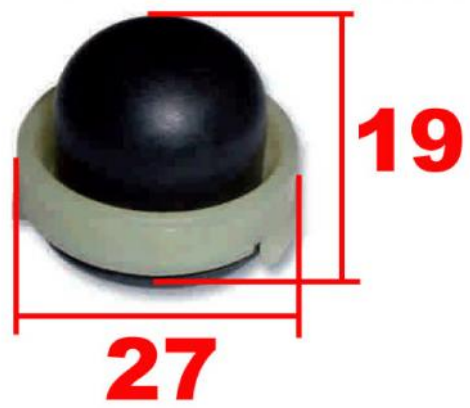

78040002

CEBADORES ADAP. KAWASAKI **Kawasaki**

TF-022 DVX, TH 023 D, TH-24, MS-055, TH-34, TE048M-
BG24, BL-5400SP, TE59D-AG20, BL-6500SP, BL-6700SP,
TJ-27 E, TJ-35 E, TJ-45 E

TD-40 / BC-402 / TD-48 / BC-480



78040010



78040011

CORTASETOS TG-18 DVX, TH-18, TE048M- BG24
BL-4800SP

TH-43, TH-48



78040012



78040014

CEBADORES ADAP. KAWASAKI

Kawasaki

TH-43, TH-44



78040016

TK-65D, AG21, BL-8100



78040018

CEBADORES ADAP. KOMATSU

KOMATSU

G 22 LS, LS-937K, LS-908K



78040020

CEBADORES ADAP. MARUYAMA



320, MP-2532, 420, BC-420H, 500, BC-500H, BKC-500, AE-200, MS-062, MS-068, BE-230, MS-073, 200-230, HT-230



78040020

CEBADORES ADAP. MI PARTS



MTS-18



BOYA OHV

78040044
78040046

OHV 140-200
OHV 240-390

78040042

CEBADORES ADAP. MITSUBISHI



T310PSD-085, BL-471



78040024

CEBADORES ADAP. ROBIN



EH-25, BL-25



78040020

CARBURADORES WALBRO



78040030



78040032



78040034



78040036

WT-119C, WT-265



78040038

CARBURADORES ZAMA



78040040

CARCASAS DE MOTOR

CARCASA VENTILADOR GX 25



78011098

CARCASA VENTILADOR GX 35



78011099

CARCASA MOTOR GX-100



78011100

CARCASA VENTILADOR GX 140-160-200



78011101

CARCASA MOTOR OHV 110-120

78011105

CARCASA VENTILADOR GX 240-270



78011103

CARCASA VENTILADOR GX 340-390



78011104

CARCASAS DE MOTOR

TAPA CARTER OHV140-200

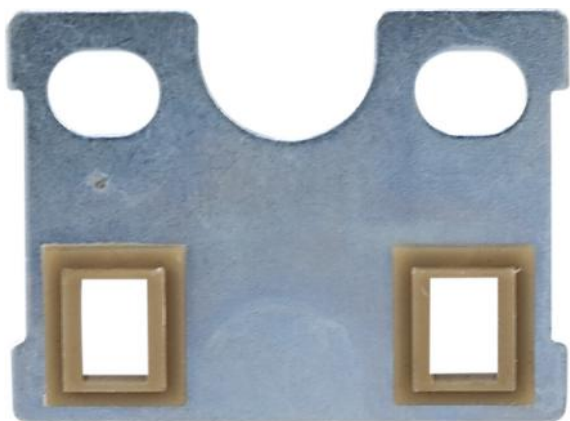

78026080

TAPA CARTER OHV240-270

78026084

TAPA CARTER OHV 390

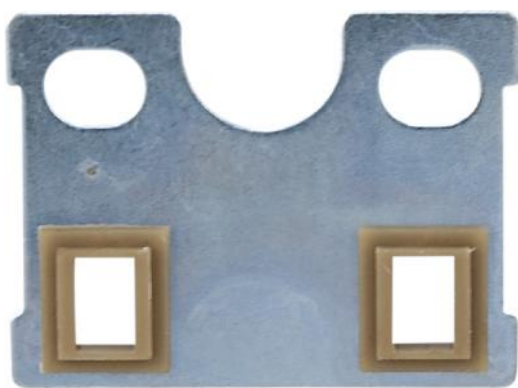

78026086

CIGÜEÑALES

HONDA

CIGÜEÑAL OHV 080 090

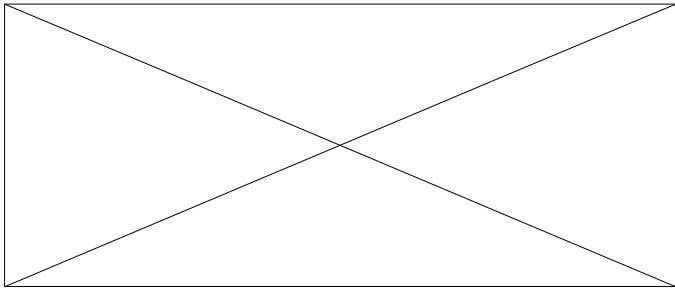

78024099P

SALIDA P

15.8 x 60

CIGÜEÑAL GX 100

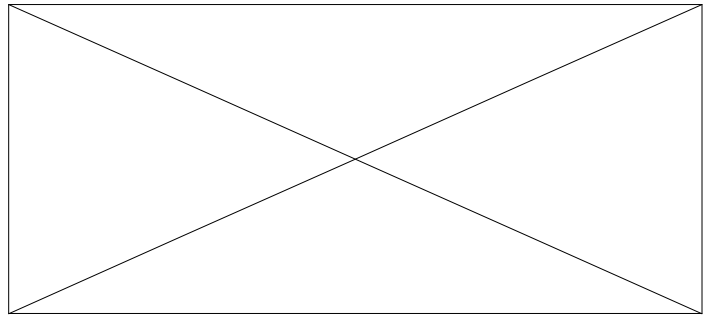

780250035

15 x 25

CIGÜEÑAL OHV 120- 883BA50H

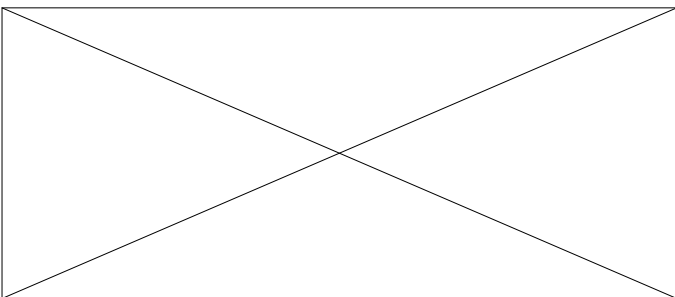

78025000R ESP.MOTOBANDA, SALIDA Q ROSC. 19 x 57

CIGÜEÑAL OHV 160 - 883BA80H

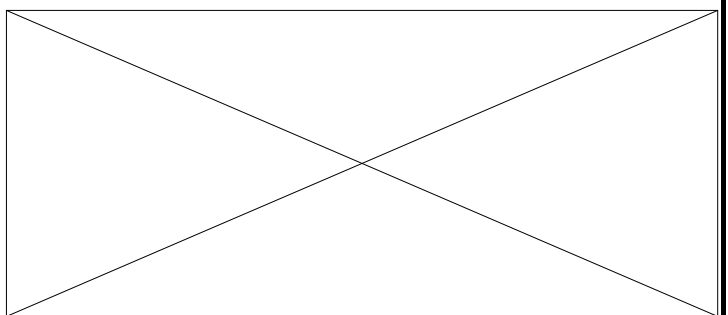

78025001R ESPC.MOTOBANDA, SALIDA Q ROSC. 19x57

CIGÜEÑAL CILINDRICO OHV160

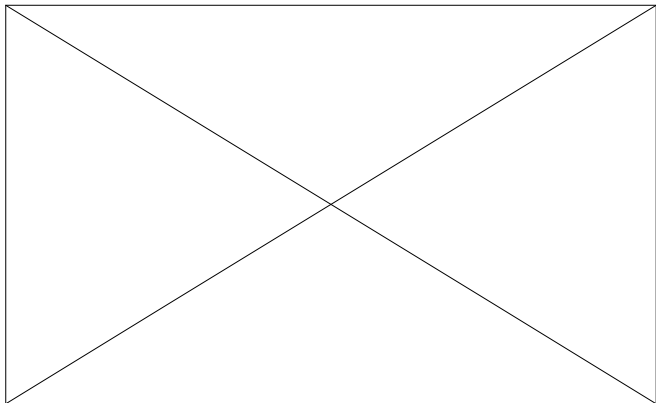

78025001L

SALIDA L

20 x 50

CIGÜEÑAL CILINDRICO OHV160

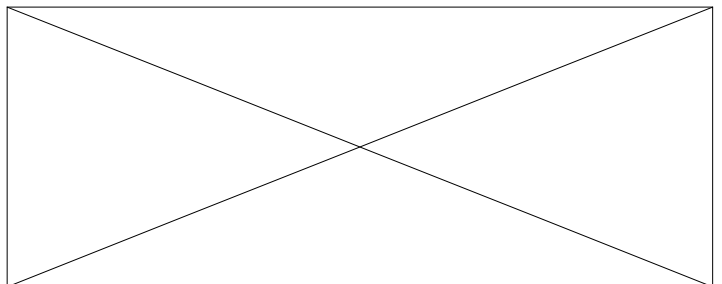

78025001Q

SALIDA Q

19.05x58.5

CIGÜEÑAL OHV160

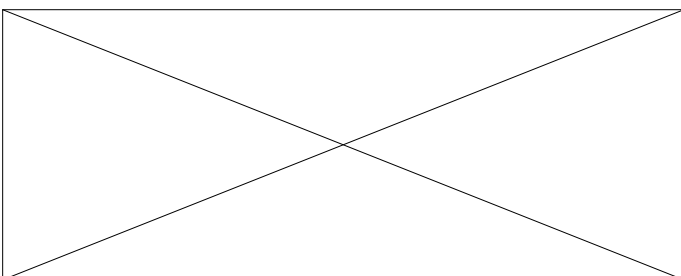

78025001S

SALIDA S

18 x 50

CIGÜEÑAL CONICO OHV160



78025001V

SALIDA V

CIGÜEÑALES

HONDA

CIGÜEÑAL OHV270 - 883BA100H

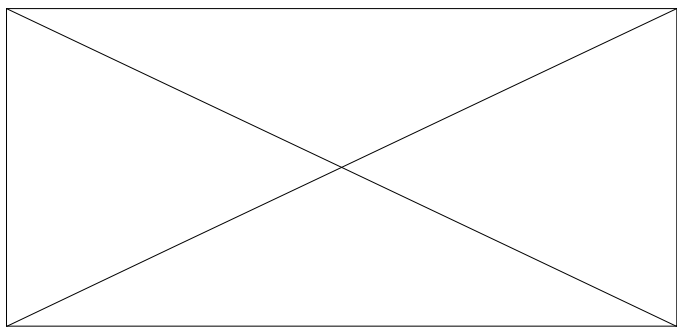

78025003R

20x25x53

CIGÜEÑAL CILINDRICO OHV270

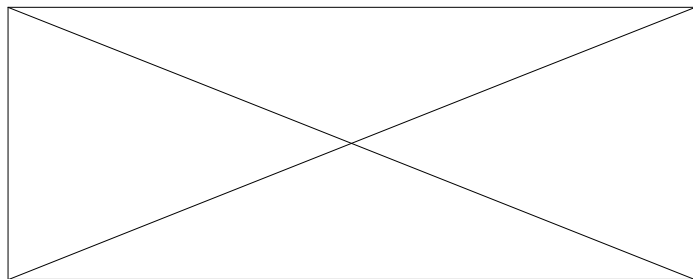

78025003Q

SALIDA Q

25,4 x 72,2

CIGÜEÑAL CILINDRICO OHV270

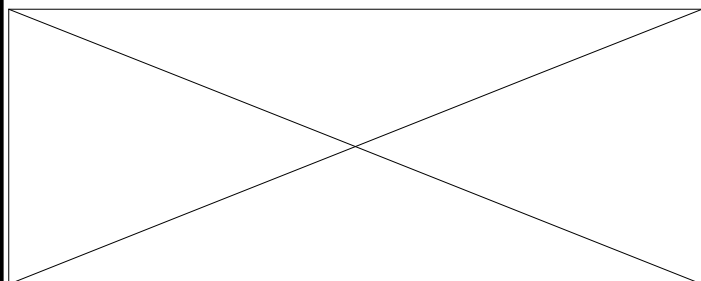

78025003S

SALIDA S

25 x 63

CIGÜEÑAL CONICO OHV270

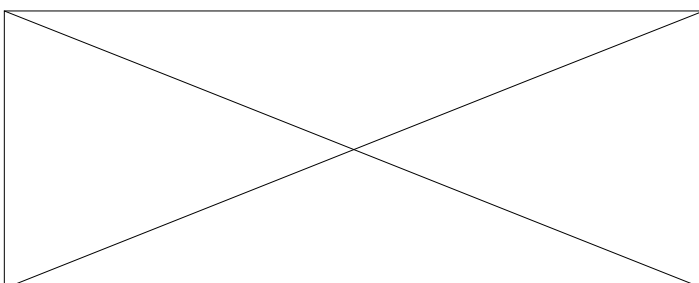

78025003V

SALIDA V

22.16 x 106

CIGÜEÑAL CILINDRICO OHV 340-390

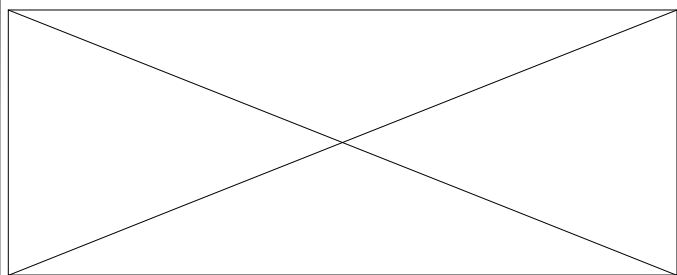

78025005Q

SALIDA Q

25,4 x 72,2

CIGÜEÑAL CILINDRICO OHV 340-390

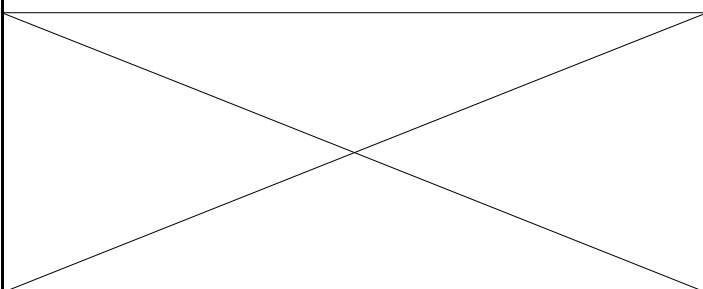

78025005S

SALIDA S

25 x 60

CIGÜEÑAL CONICO OHV 390

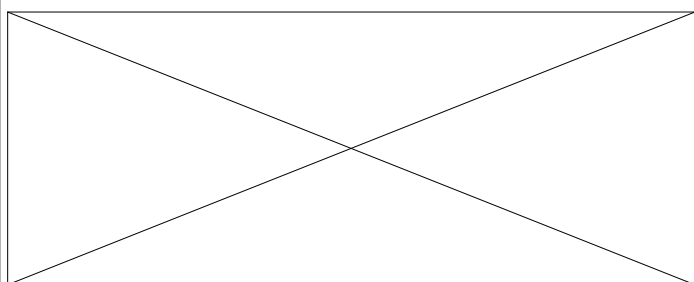

78025005V

SALIDA V

22,16 x 106

CIGÜEÑAL OHV 160

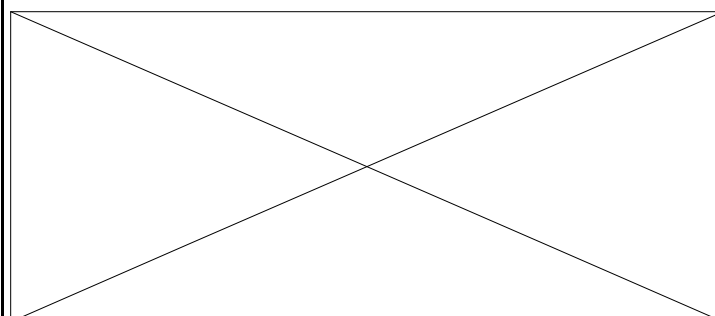

78025001VM

SALIDA VM

15,5 - Ø

CIGÜEÑALES

HONDA

CIGÜEÑAL CONICO OHV 390

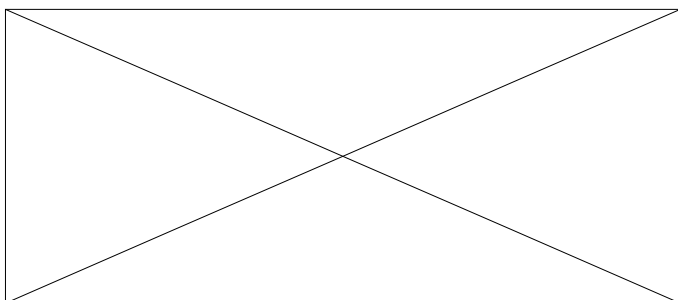

78025005VL SALIDA V 22.16 x 106

CIGÜEÑAL CILINDRICO OHV620

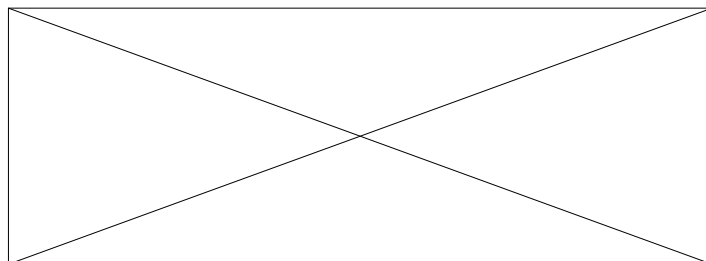

78025006Q SALIDA V 25 x 72,2

CIGÜEÑAL CONICO OHV620



78025006V SALIDA V 137x38x35

CIGÜEÑAL CONICO OHV 240 a 270

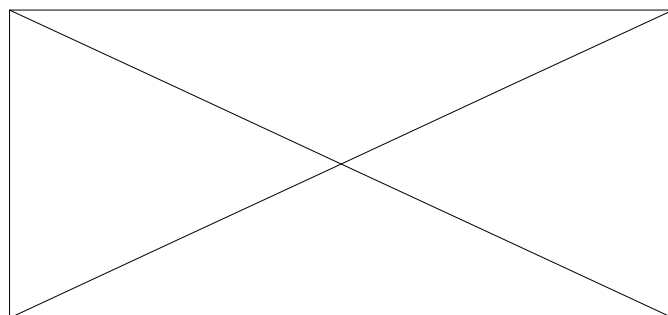

78423000 SALIDA V 138,4x30x25x22,10

CIGÜEÑAL CILINDRICO OHV 200

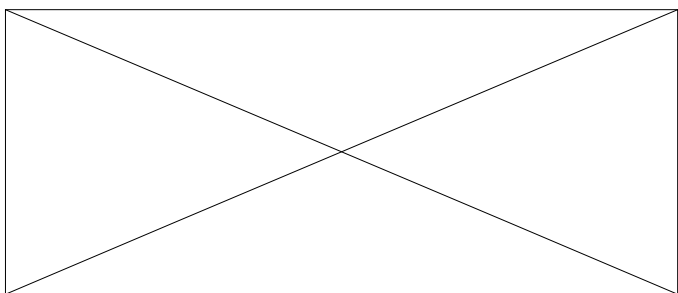

78613000 SALIDA Q 19,05 x 58,50

CIGÜEÑAL CILINDRICO OHV 200

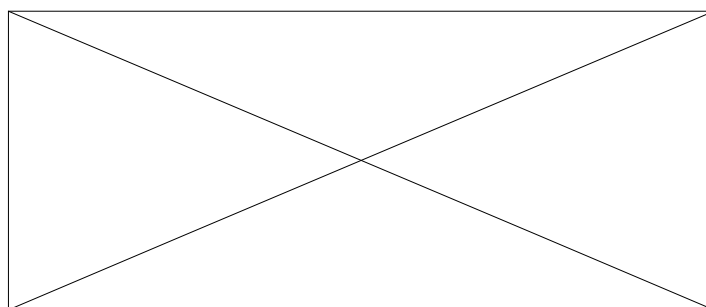

92MT200/10/2 SALIDA S 20 x 50

CIGÜEÑALES

HUSQVARNA

CIGÜEÑAL CPL 55

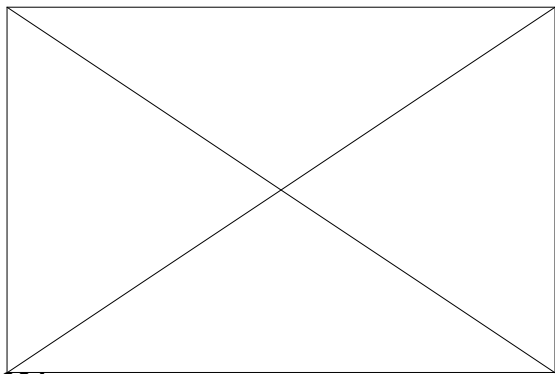

CG004

CIGÜEÑAL CPL 281,288

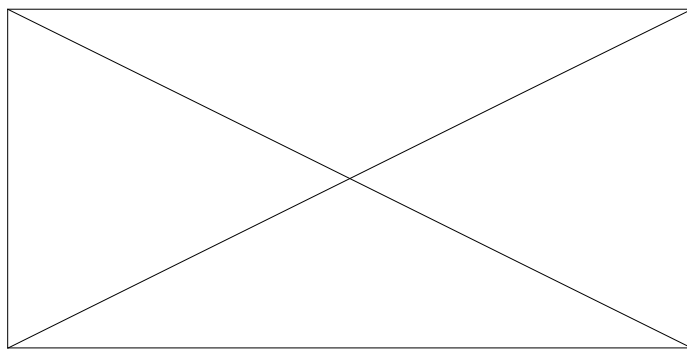

CG001

CIGÜEÑAL CPL 365, 372

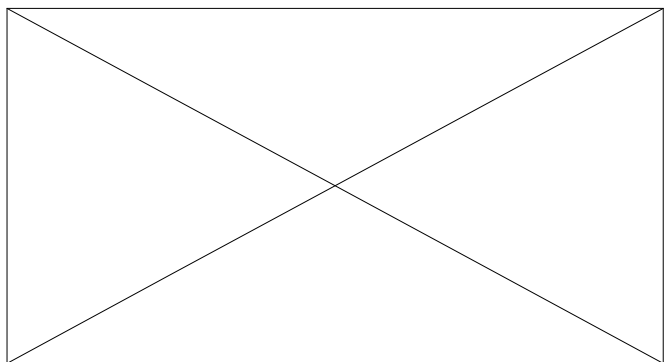

CG002

CIGÜEÑAL CPL 385

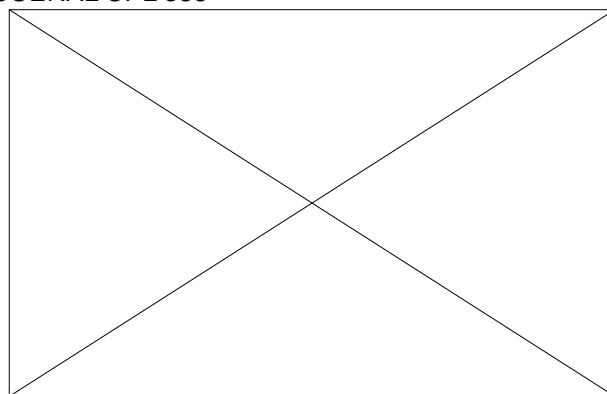

CG003

STIHL

CIGÜEÑAL CPL 018, 180, MS180

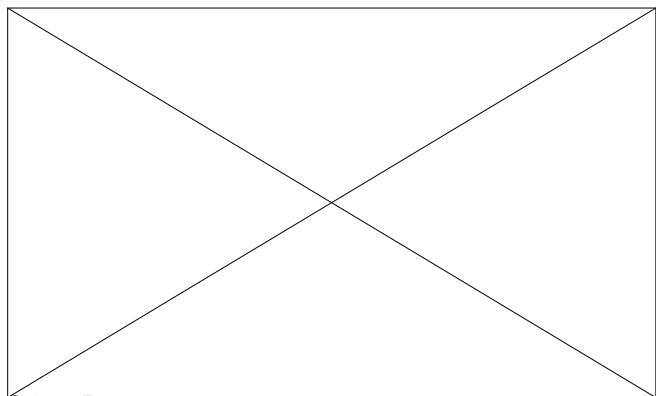

CG005

CIGÜEÑAL CPL 026, MS260

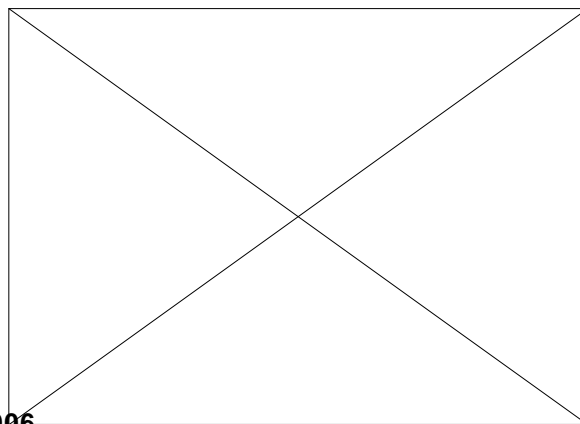

CG006

CIGÜEÑAL CPL 034, 036, MS340/360

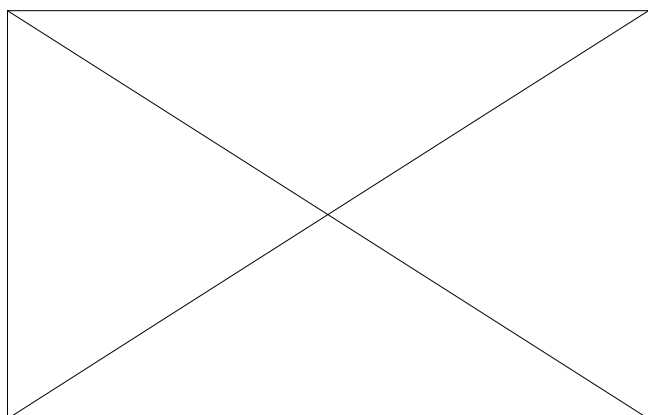

CG007

CIGÜEÑAL CPL 038, MS380

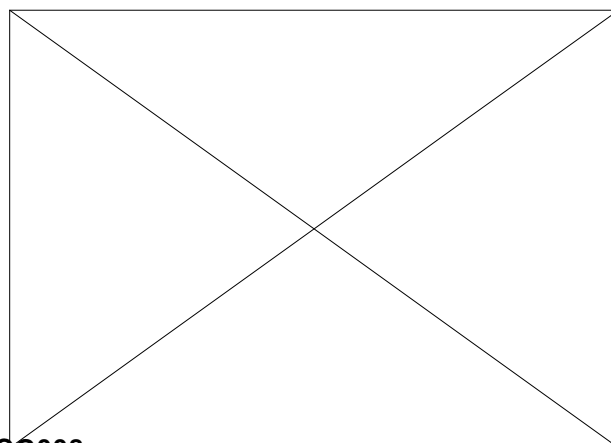

CG008

CIGÜEÑALES

STIHL

CIGÜEÑAL CPL 044

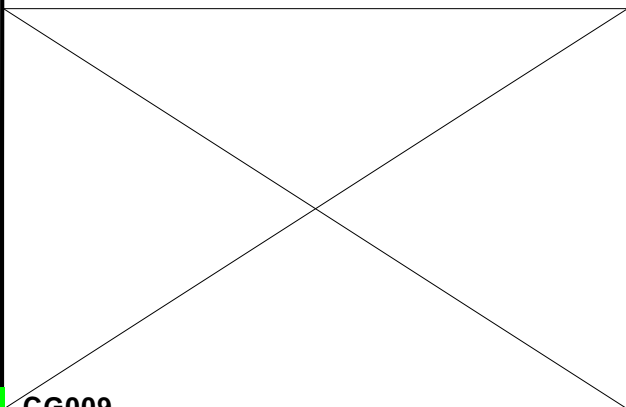

CG009

CIGÜEÑAL CPL 066, MS660

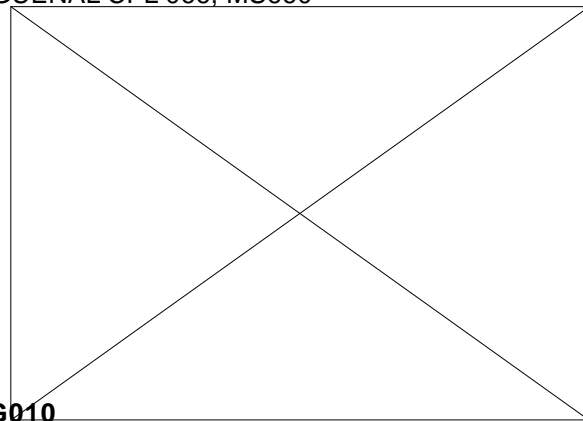

CG010

CIGÜEÑAL MS250

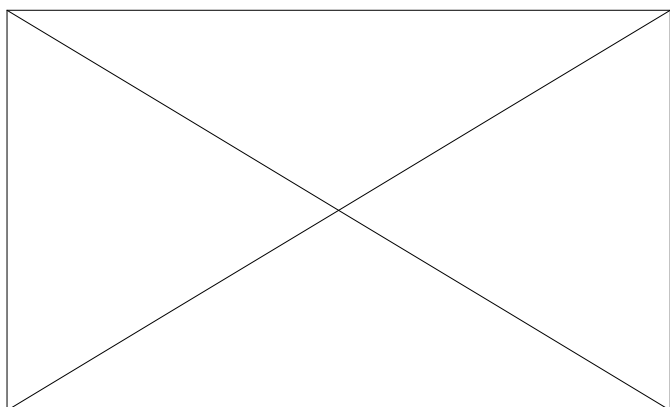

CG011

CULATAS, VALVULAS Y BALANCINES

<p>KIT VALVULA, ADMISION Y ESCAPE</p> <p>78026004 ADMISION OHV 80-90 78026005 ESCAPE OHV 80-90 78026014 OHV110 78026000 OHV120 78026015 OHV140 78026001 OHV160 78026093 OHV160(VERTICAL) 78026090 OHV200 78026091 OHV240 78026002 OHV270 78026092 OHV340 78026003 OHV390 78026006 ADMISION OHV 620 78026007 ESCAPE OHV 620</p> 	<p>CASQUILLO VALVULA</p>  <p>78026071 H100 78026072 OHV-160 78026073 OHV110-120 78026074 OHV-200 78026075 OHV340-390</p>	
<p>PLATILLO VALVULA</p>  <p>78026050 OHV 080-090 78026051 H 100-152 78026052 OHV 110-120 78026054 OHV 140-200 78026055 OHV 240-270 78026056 OHV 340-390</p>	<p>ELEVADOR VALVULAS</p>  <p>78026008 OHV80-90 78026016 OHV110-120 78026017 OHV140-200 78026018 OHV240-270 78026019 OHV340-390</p>	<p>RETEN DE VALVULAS</p>  <p>78026011 OHV160 78026012 OHV270 78026013 OHV390</p>
<p>GUIA VALVULAS</p>  <p>78034100 OHV110-120 78134100 OHV140-160 78234100 OHV200 78434100 OHV270 78634100 OHV390</p>	<p>CHAPA GUIA VALVULAS</p>  <p>78026080 OHV110-120 78026082 OHV140-160-200 78026084 OHV240-270 78026086 OHV340-390 78026088 OHV340-390 NYLON</p>	<p>MUELLE VALVULAS</p>  <p>78026041 OHV120-160-200 78026042 OHV240-270-390</p>
<p>EMPUJADOR DE VALVULAS</p>  <p>78026009 OHV80-90 78244100 OHV110-120 78344100 OHV160 78444100 OHV240-270 78544100 OHV340-390 78644100 OHV160(VERTICAL) 78026010 OHV 620</p>	<p>KIT BALANCINES</p>  <p>78027001 OHV 160</p>	<p>KIT BALANCINES</p>  <p>78027002 OHV 270</p>

CULATAS, VALVULAS Y BALANCINES

KIT BALANCINES



78027003

OHV 390

KIT BALANCINES



78027004

OHV 110-120

KIT BALANCINES



78027005

OHV 140-160 VERTICAL

KIT BALANCINES



78027000

OHV80-90

KIT BALANCINES



78027006

OHV620

TAPA DE JUNTA CULATA



78028005

OHV80-90

CULATA



78028000

OHV 80-90

CULATA OHV120



78253000

OHV120

CULATA OHV160



78028001

OHV160

CULATA OHV 200

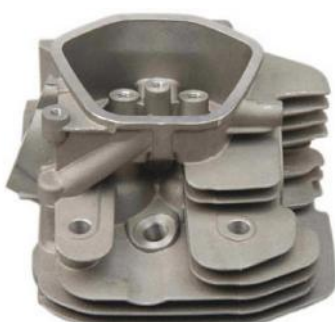

78028004

OHV200

CULATA OHV 240



78028005

OHV240

CULATA OHV270



78028002

OHV270

CULATAS, VALVULAS Y BALANCINES

CULATA OHV 340



78028006

OHV 340

CULATA OHV390



78028003

OHV390

CULATA IZQUIERDA OHV620



78028007 (IZQ)

OHV 620

CILINDRO



78026030
78026032
78026034
78026036
78026038
78026040

OHV 120
 OHV 160
 OHV 200
 OHV 270
 OHV 340
 OHV 390

CULATA DERECHA OHV 620



78028008 (DCHA)

OHV 620

CULATA COMPLETA OHV

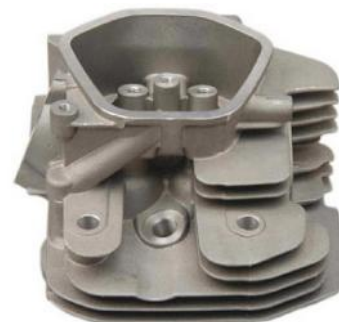

785471560
789571560

OHV 240 - 270
 OHV 390

DEPOSITOS HONDA

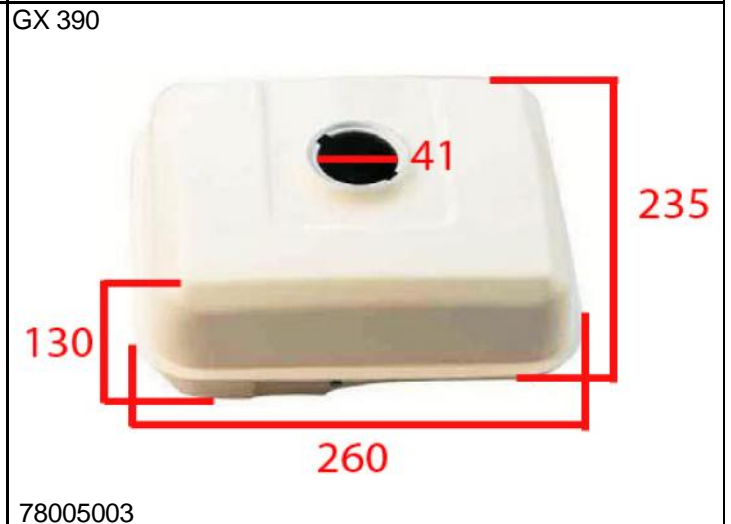
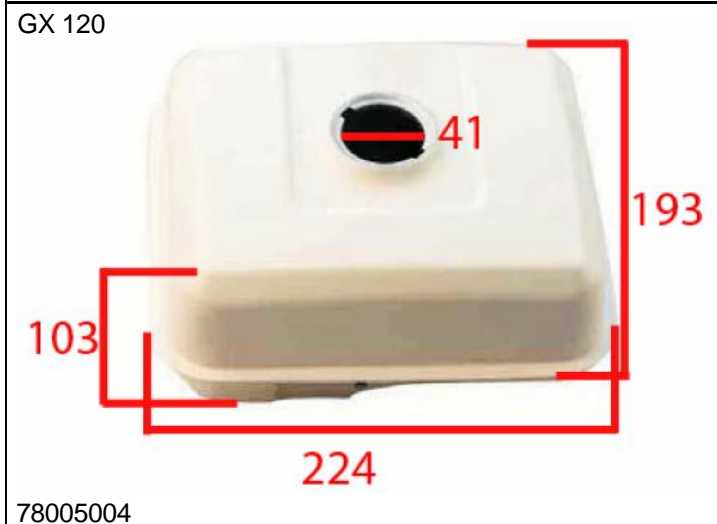
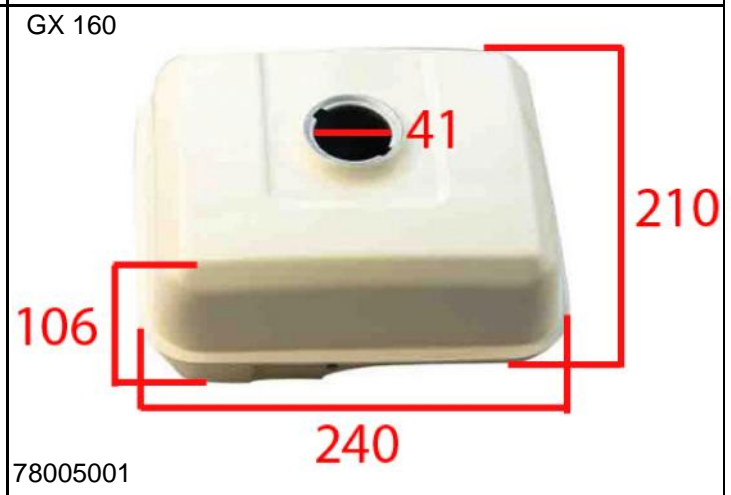
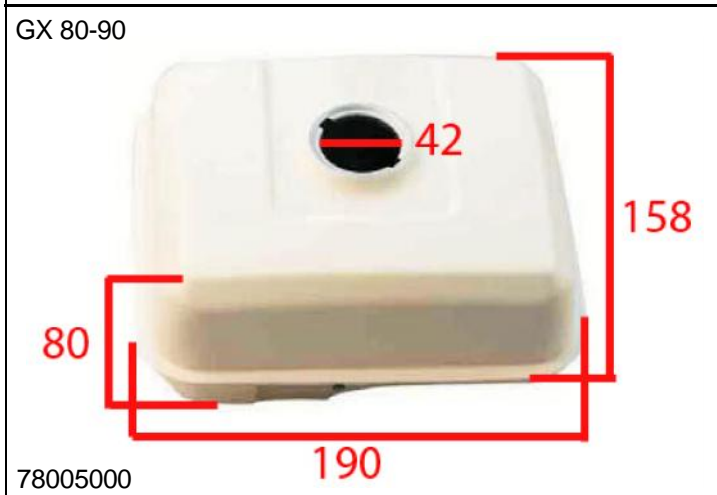
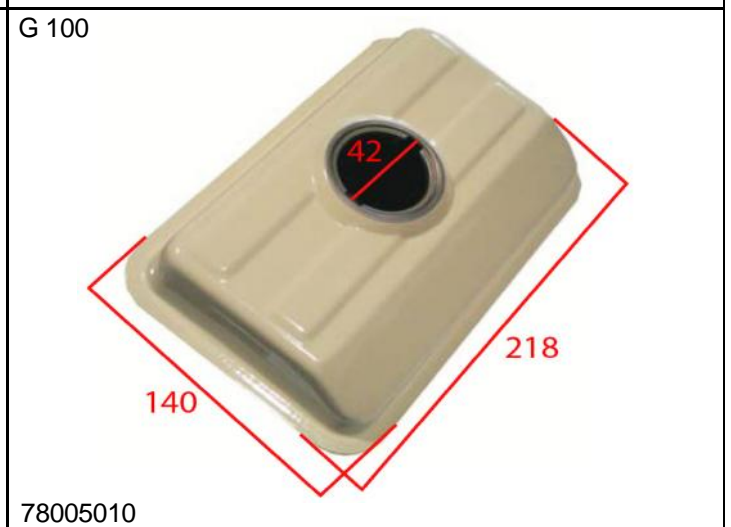
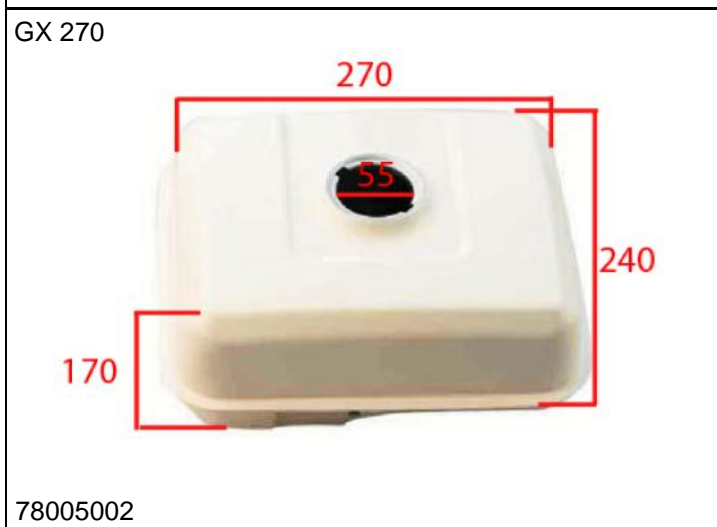
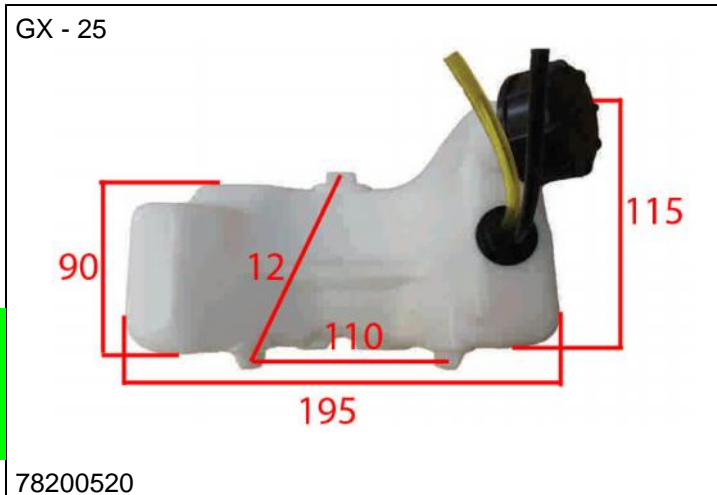

DEPOSITOS KAWASAKI

TH - 43

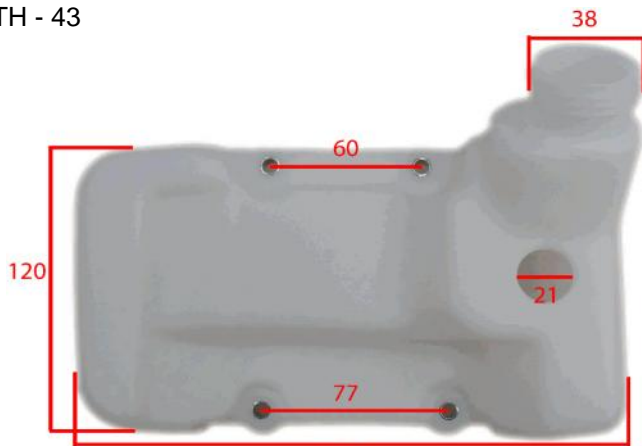

78200684

210

TH-23

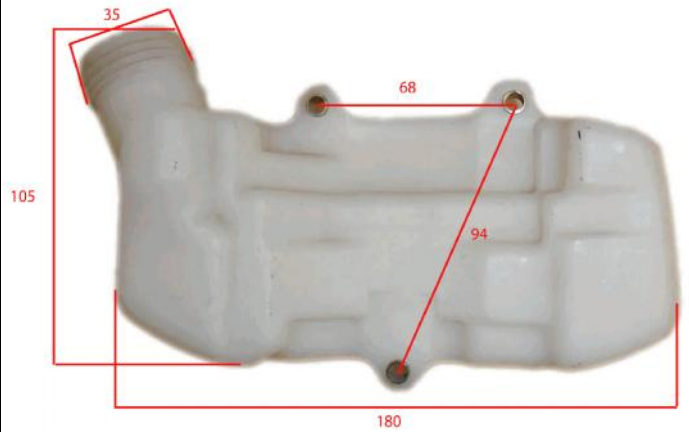

78200676

TE048M-BG20, BL -48000SP



78200680

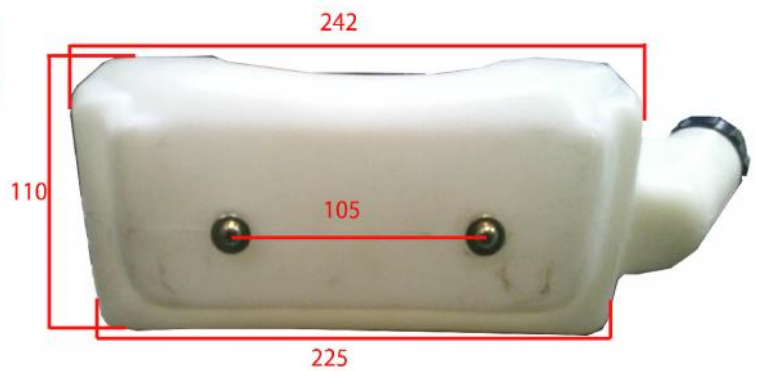

TH-23

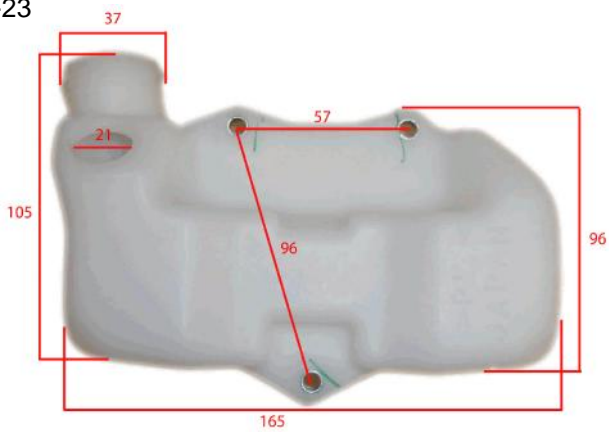

78200682

DEPOSITOS MI GARDEN

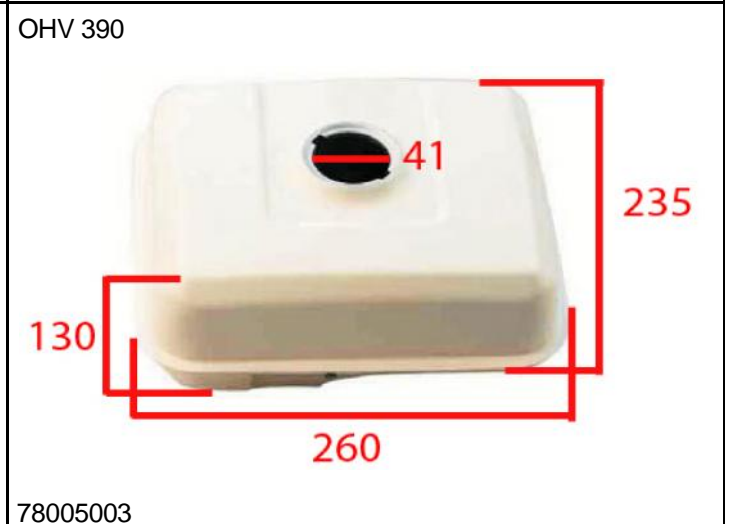
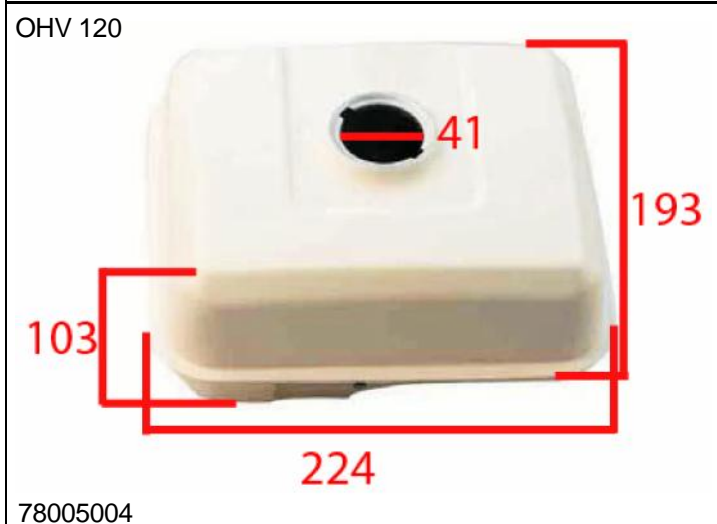
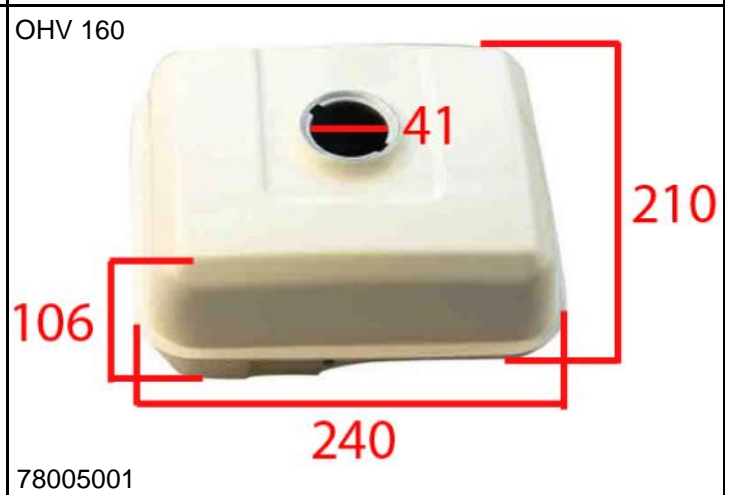
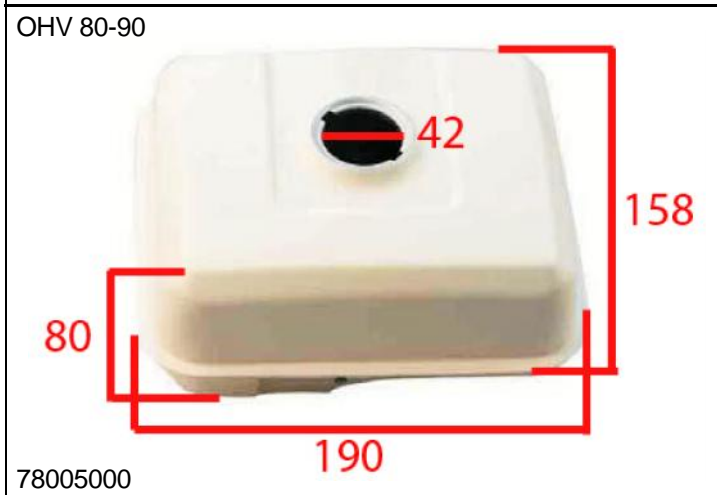
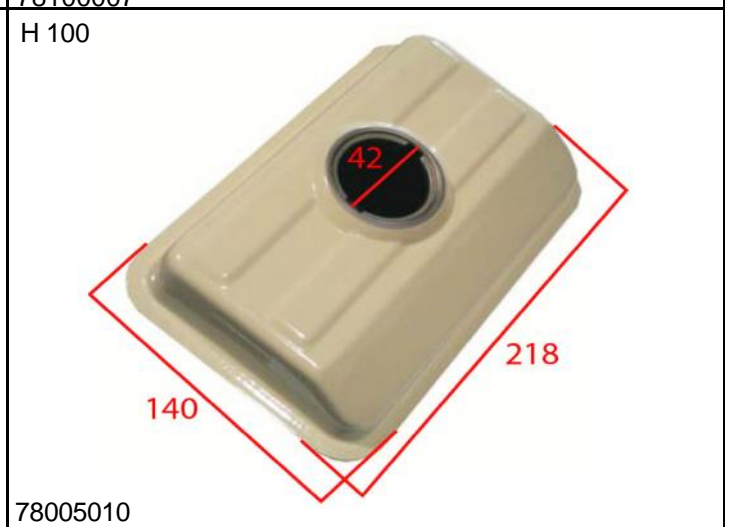
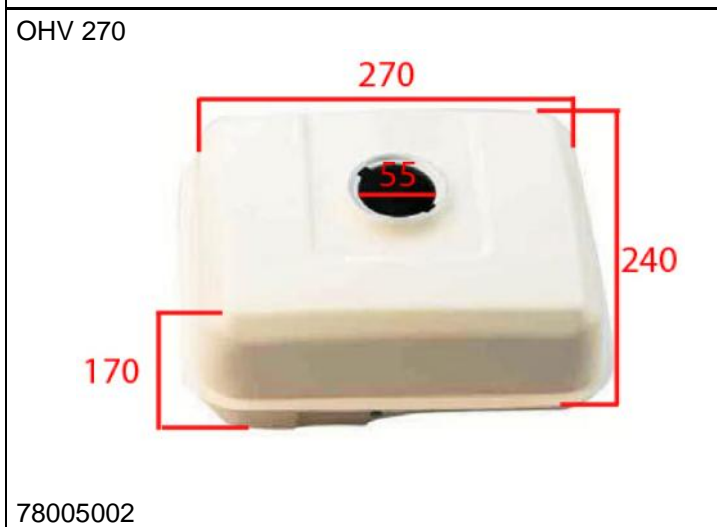
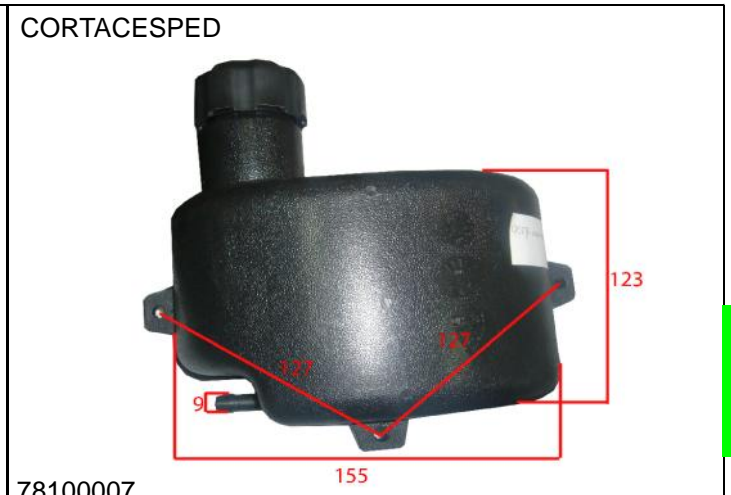
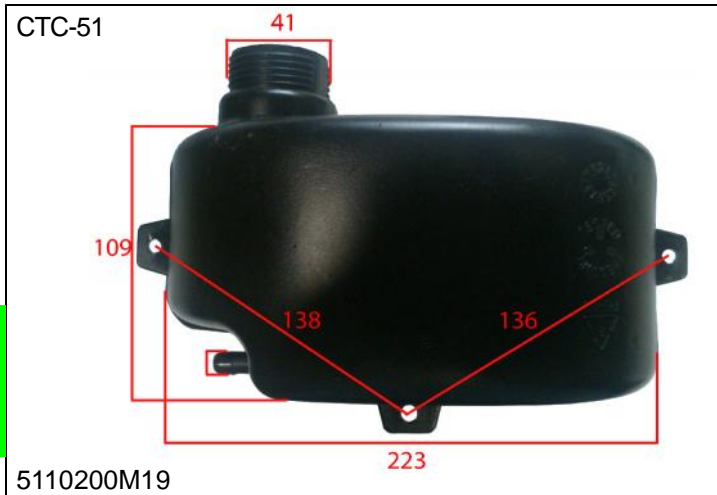

DEPOSITOS MI GARDEN

MT-25



6500 25L



78200540
2500



188650014
1050

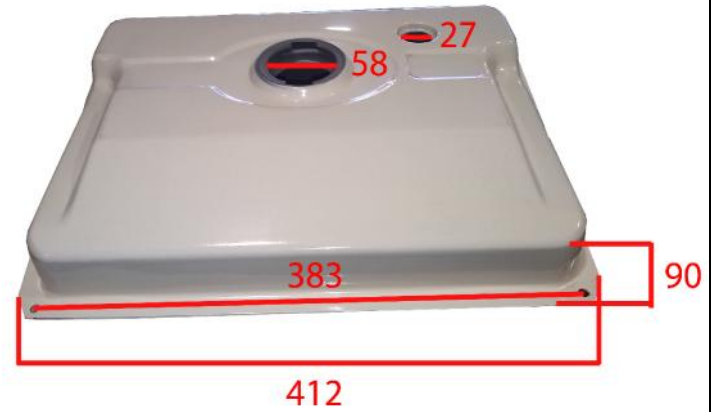

118250005
DESBROZADORA 51



188105017
DESBROZADORA 42

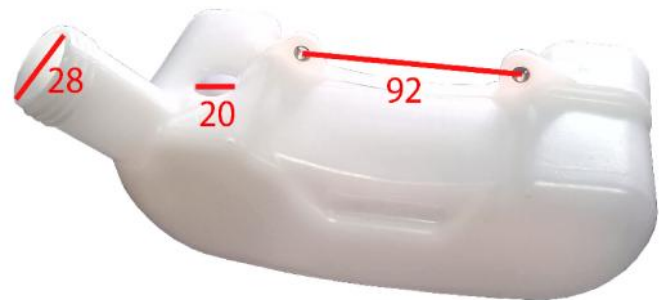

KM0408520P187
DESBROZADORA 32

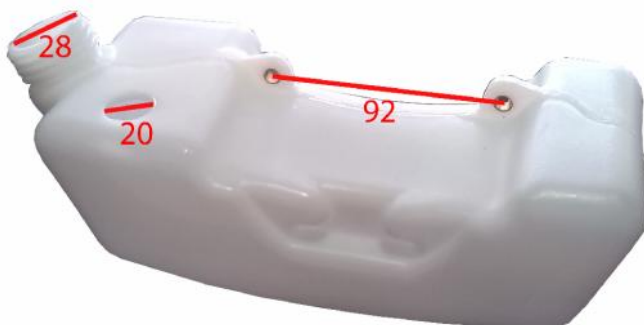

50D427P183

KM0408330P181

DEPOSITOS ROBIN

ECO 25

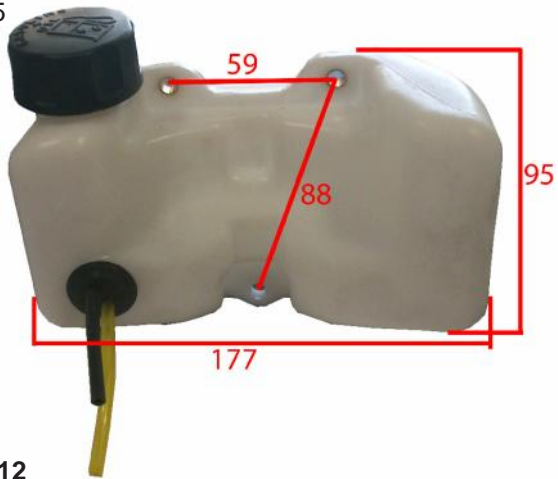

78200712

EH-09



78200714



78200716



78200718

DEPOSITOS MARUYAMA

BE-230, MS-073

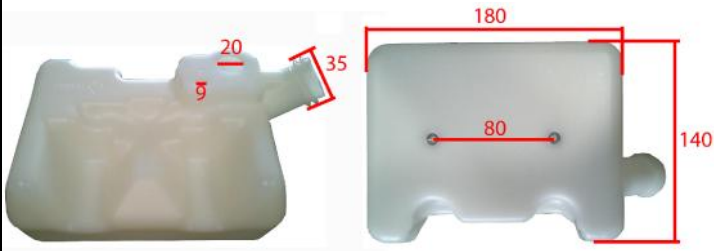

ME-435 MD-150-DX

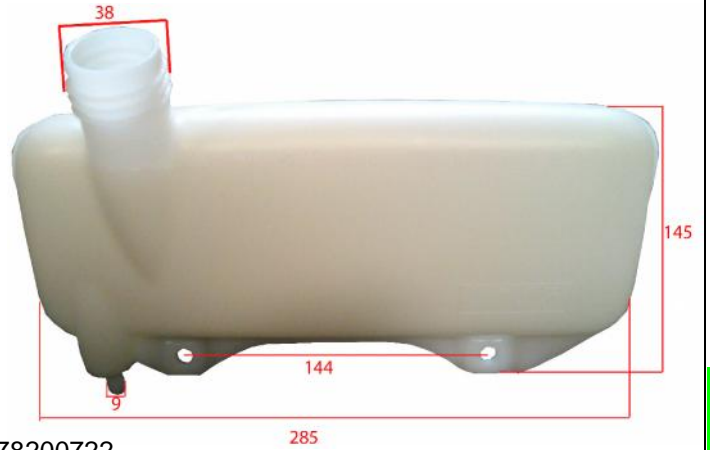

78200686

AE -200P MS-062



78200698

78200722

MD-055, MS-056

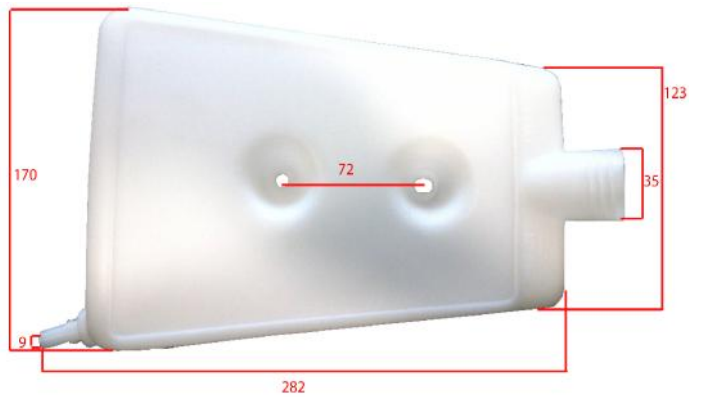

78200720

EQUIPOS DE MOTOR ADAP'. ALPINA

PARA 52.

Ref. Org. 854-0970



79020203

EQUIPO DE MOTOR COMPLETO Ø 45 mm

EQUIPOS DE MOTOR ADAP. HUSQVARNA

PARA 45, 245-R.



79060202 (45, 245)

79060222 (240-R)

79060203

PISTON Ø 42 mm

PISTON Ø 42 mm

EQUIPO DE MOTOR COMPLETO Ø 42 mm

PARA 51.



79060403

79060402

EQUIPO DE MOTOR COMPLETO Ø 45 mm

PISTON Ø 45 mm

PARA 55.



79060802

79060803

PISTON Ø 46 mm

EQUIPO DE MOTOR COMPLETO Ø 46 mm

PARA 61, 66.



79061002

79061003

PISTON Ø 48 mm

EQUIPO DE MOTOR COMPLETO Ø 48 mm

PARA 240R, 40, 2041.



79061202

79061203

PISTON Ø 40 mm

EQUIPO DE MOTOR COMPLETO Ø 40 mm

PARA 268, 268-S. JONSERED 670. Ref: Org:503611071, 544222902



79061303

EQUIPO DE MOTOR COMPLETO Ø 50 mm

PARA 340.



79061402

79061403

PISTON Ø 40 mm

EQUIPO DE MOTOR Ø 40 mm

EQUIPOS DE MOTOR ADAP. HUSQVARNA

PARA 350.



79061602

PISTON Ø 44 mm

79061603

EQUIPO DE MOTOR COMPLETO Ø 44 mm

PARA 357, 359.



79061803

Ø 47 mm

PARA 365. JONSERED 2165.



79062003

EQUIPO DE MOTOR COMPLETO Ø 48 mm



PARA 372.



79062203

EQUIPO DE MOTOR COMPLETO Ø 52 mm

EQUIPOS DE MOTOR ADAP. KAWASAKI

<p>TH-43. Ref.org. 11005-2123</p>  <p>79080201 79080202 79080203</p> <p>SEGMENTOS Ø 41 mm PISTON Ø 41 mm EQUIPO DE MOTOR COMPLETO Ø 41,5 mm</p>	<p>TH-48. Ref.org.11005-2122</p>  <p>79080401 79080402 79080403</p> <p>SEGMENTOS Ø 44 mm PISTON Ø 44 mm EQUIPO DE MOTOR COMPLETO Ø 44 mm</p>

EQUIPOS DE MOTOR ADAP. KOMATSU

ZENOAH 5200.



79100203

EQUIPO DE MOTOR COMPLETO Ø 45 mm

ZENOAH EB-650.



79100403

EQUIPO DE MOTOR COMPLETO Ø 48 mm

EQUIPOS DE MOTOR ADAP. MAKITA-DOLMAR

PARA.6200, 6400, 6410.

Ref:Org:335130031



79110203

EQUIPO DE MOTOR COMPLETO Ø 46 mm

EQUIPOS DE MOTOR ADAP. MIGARDEN

KIT COMPLETO CILINDRO ,PISTON SEGMENTOS

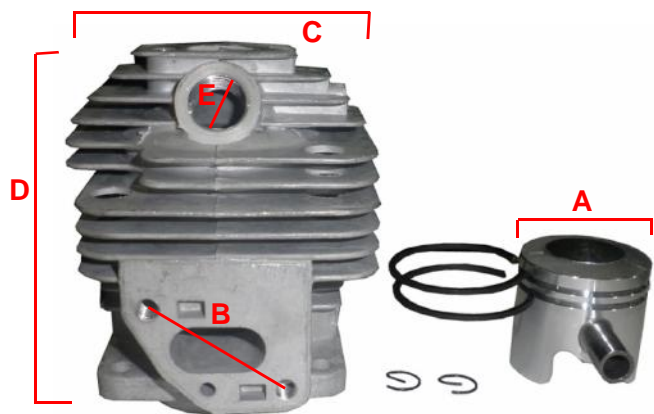

REF.	A	B	C	D	E	cc
2T25-10	34	33	65	70	12	25.4cc
2T32-10	36	36	73	87	12	32.6cc
2T42-10	40	37	86	96	12	42.7cc
2T51-10	43	37	86	96	12	51.7cc

KIT COMPLETO CILINDRO/SEGM/PISTON/
ATOMIZADOR DE POLVO Y AGUA 42cc

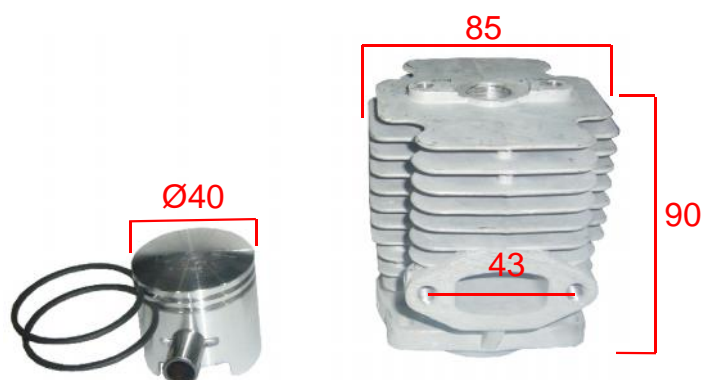

0407420-4

KIT COMPLETO CILINDRO/SEGM/PISTON
SOPLADORA 63.3cc

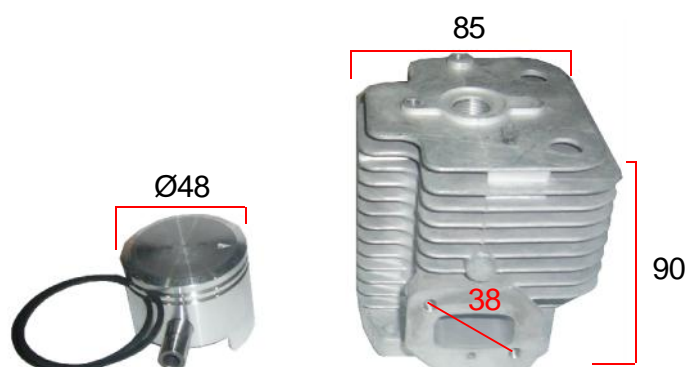

0410630-4

KIT COMPLETO CILINDRO/SEGM/PISTON/ CORTACESPED

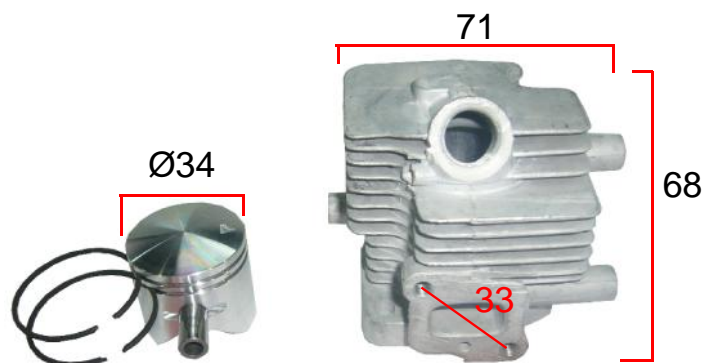

0403028-4

EQUIPOS DE MOTOR ADAP. MITSUBISHI

TL-43, KUBOTA430.

Ref. Org. KC13010AA



79140203

EQUIPO DE MOTOR COMPLETO Ø 40 mm

TL-52, KUBOTA520.



79140403

EQUIPO DE MOTOR COMPLETO Ø 44 mm

EQUIPOS DE MOTOR ADAP. PARTNER

K-1250.

Ref. Org. 506294271



79160403

EQUIPO DE MOTOR COMPLETO

P-650, K-650.

Ref. Org. 506099212



79160203

EQUIPO DE MOTOR COMPLETO

EQUIPOS DE MOTOR ADAP. ROBIN

EC-025.



79180203

EQUIPO DE MOTOR COMPLETO

EQUIPOS DE MOTOR ADAP. STIHL

<p>017. Ref: Org. 11300201204</p>  <p>79200203 EQUIPO DE MOTOR COMPLETO Ø 37 mm</p>	<p>018, MS-180. BULON Ø8mm. Ref: Org. 11300201205</p>  <p>79200402 PISTON Ø 38 mm 79200403 EQUIPO DE MOTOR COMPLETO Ø 38 mm</p>
<p>023, 230. Ref: Org. 11230201214</p>  <p>79200602 PISTON Ø 40 mm 79200603 EQUIPO DE MOTOR COMPLETO Ø 40 mm</p>	<p>025, 250 Ref: Org. 11230201206</p>  <p>79200802 PISTON Ø 42 mm 79200803 EQUIPO DE MOTOR COMPLETO Ø 42 mm</p>
<p>026, MS260. Ref: Org. 1121-020-1217</p>  <p>79201002 PISTON Ø 44 mm 79201003 EQUIPO DE MOTOR COMPLETO Ø 44.7 mm</p>	<p>028. Ref: Org. 1118-020-1203</p>  <p>79201202 PISTON Ø 44 mm 79201203 EQUIPO DE MOTOR COMPLETO Ø 46 mm</p>
<p>029, MS-290, MS-390. Ref: Org. 1127-020-1210</p>  <p>79201403 EQUIPO DE MOTOR COMPLETO Ø 46 mm</p>	<p>036, MS-360. Ref: Org. 11250201215, 11250201216, 11250201213.</p>  <p>79201503 EQUIPO DE MOTOR COMPLETO Ø 48 mm</p>

EQUIPOS DE MOTOR ADAP. STIHL

<p>044, MS440. Ref: Org. 1128-020-1227</p>  <p>79201602 79201603</p> <p>PISTON Ø 50 mm EQUIPO DE MOTOR COMPLETO Ø 50 mm</p>	<p>046, MS-460. Ref: Org. 1128-020-1217, 1128-030-2009</p>  <p>79201802 79201803</p> <p>PISTON Ø 52 mm EQUIPO DE MOTOR COMPLETO Ø 52 mm</p>
<p>066, MS-660. Ref: Org. 11220201209</p>  <p>79201903</p> <p>PISTON Ø 54 mm</p>	<p>180.</p>  <p>79202003</p> <p>EQUIPO DE MOTOR COMPLETO Ø 38 mm</p>
<p>BR-400, BE-420. Ref: Org. 42030201201</p>  <p>79202202 79202203</p> <p>PISTON Ø46 mm EQUIPO DE MOTOR COMPLETO Ø46 mm</p>	<p>FR-350,FR-450,FR-480. Ref: Org. 4128-020-1202</p>  <p>79202403</p> <p>EQUIPO DE MOTOR COMPLETO Ø 44 mm</p>
<p>FS-200, FS-220. Ref: Org.4134-020-1212, 4119-020-1204</p>  <p>79202602 79202603</p> <p>PISTON Ø 38 mm EQUIPO DE MOTOR COMPLETO Ø 38 mm</p>	<p>FS-350, FS-400, FS-450, FS-480 Ref: Org.4128-020-1211</p>  <p>79202802 79202803</p> <p>PISTON Ø 42mm EQUIPO DE MOTOR COMPLETO Ø 42mm</p>

EQUIPOS DE MOTOR ADAP. STIHL

FS-550.

Ref: Org.4116-020-1215



79203002
79203003

PISTON Ø 46mm
EQUIPO DE MOTOR COMPLETO Ø 46mm

SP-450.

Ref: Org.4128-020-1211



79203202
79203203

PISTON Ø 44mm
EQUIPO DE MOTOR COMPLETO Ø 42mm

TS-400.

Ref: Org. 42230201200



79203403

EQUIPO DE MOTOR COMPLETO Ø 48,5 mm

TS-410, TS-420

Ref: Org. 4238-020-1202



79203603

EQUIPO DE MOTOR COMPLETO

EQUIPOS DE MOTOR ADAP. STIHL

TS-700, TS-800.

Ref: Org. 4224-020-1202



79204003

EQUIPO DE MOTOR COMPLETO Ø 56 mm

EQUIPOS DE MOTOR ADAP. WACKER

BS-60.

Ref: Org. 0099336



79220203

EQUIPO DE MOTOR COMPLETO

ESCAPES HONDA Y MI GARDEN

TUBO ESCAPE DE OHV 20HP

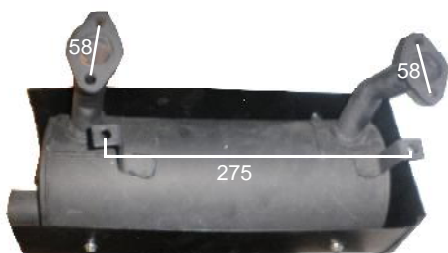

78009006

OHV 620

PROTECTOR TUBO DE ESCAPE



78024000
78024001
78024002
78024003

OHV 80-90
OHV 160
OHV 270
OHV 390

TUBO ESCAPE



78009000
78009001
78009002
78009003

OHV 80-90
OHV 160
OHV 270
OHV 390

DEFLECTOR DE GASES OHV110-200



78024005

DEFLECTOR DE GASES OHV240-390



78024006

TUBO ESCAPE



78009010

H100



188190081

0408520

CODO COLECTOR ESCAPE



78010002
78010003

OHV 270
OHV 390

H100



78009010



408520160



040325131

50H Y OHV 120



188500026

ESCAPES HONDA Y MI GARDEN

80H, OHV 160



188800020

G 2500



188250025

ESCAPE OHV 240



78009004

OHV 160



78009001

OHV 390



78009003

OHV 270



78009002

OHV 080 090



78009000

GRIFOS COMBUSTIBLE

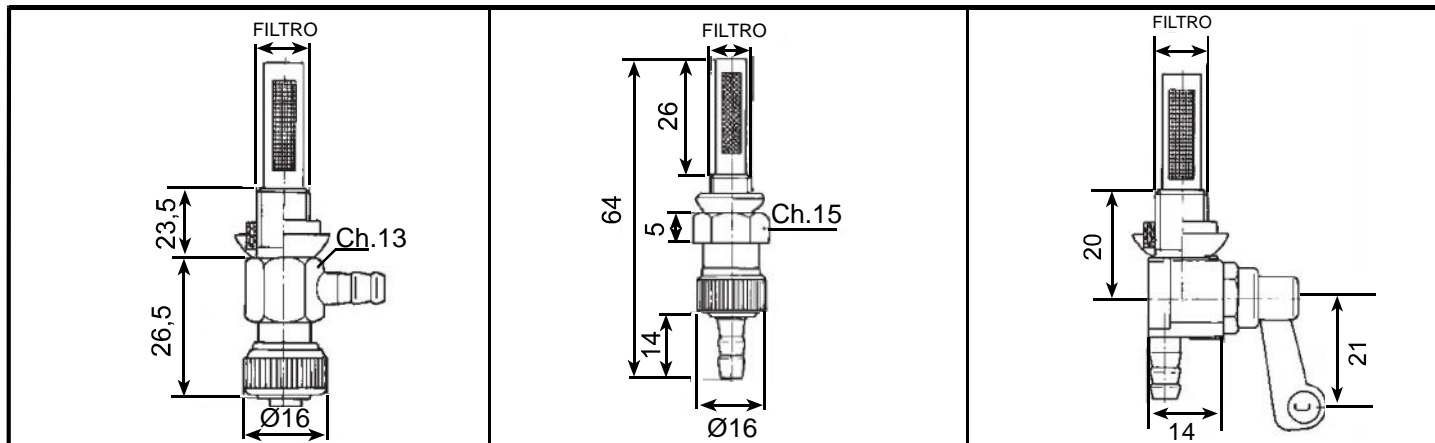

REF.	FILTRO	SALIDA	RESERVA	REF.	FILTRO	SALIDA	RESERVA	REF.	FILTRO	SALIDA	RESERVA
121900	10x1	Ø6	NO	121910	10x1	Ø6	NO	121920	10x1	Ø6	NO

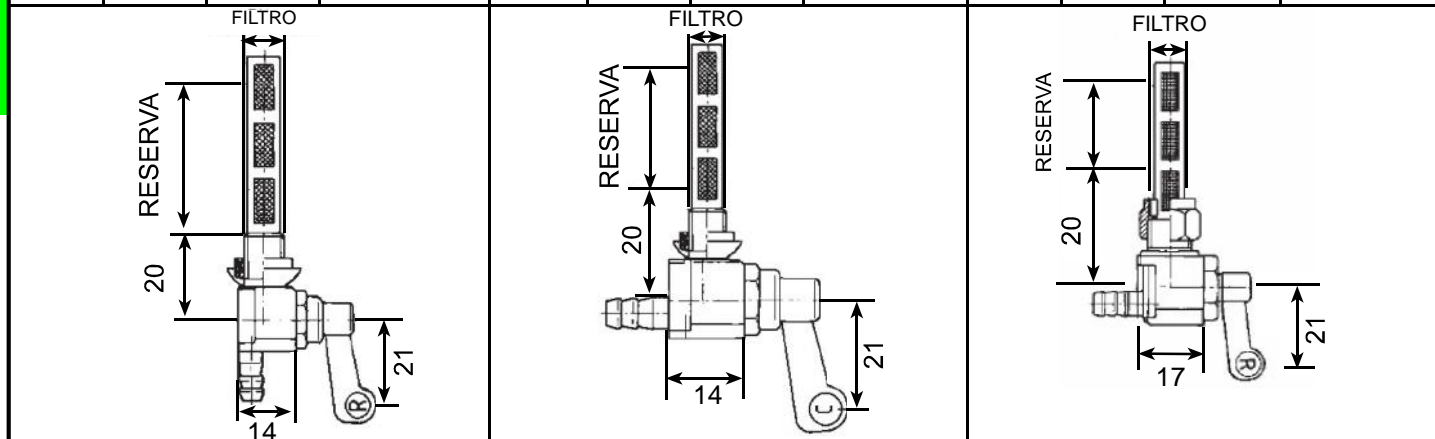

REF.	FILTRO	SALIDA	RESERVA	REF.	FILTRO	SALIDA	RESERVA	REF.	FILTRO	SALIDA	RESERVA
121930	10x1	Ø6	SI	121940	10x1	Ø6	SI	121950	12x1	Ø6	SI

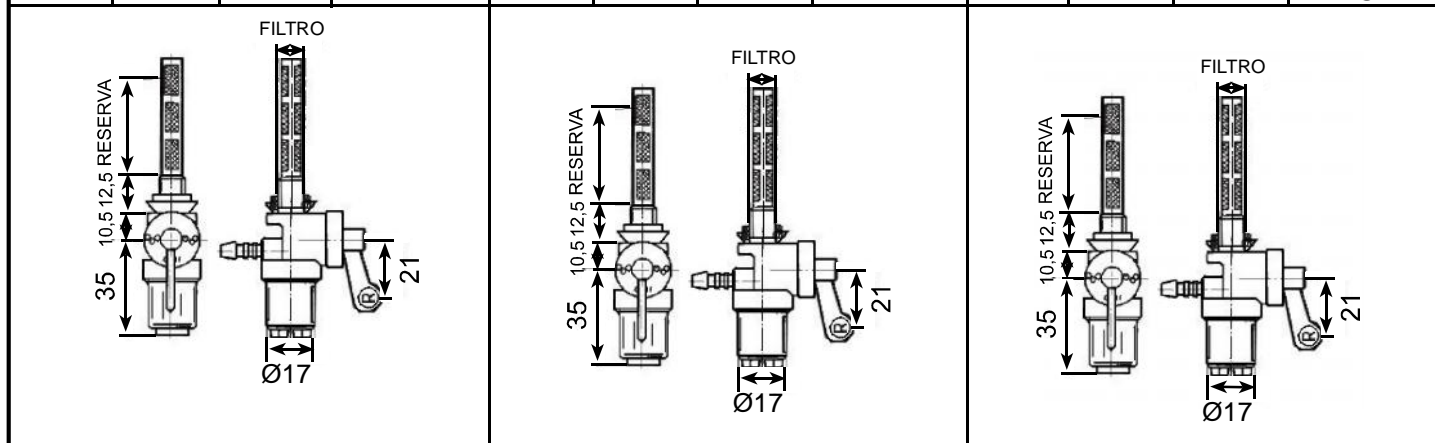

REF.	FILTRO	SALIDA	RESERVA	REF.	FILTRO	SALIDA	RESERVA	REF.	FILTRO	SALIDA	RESERVA
121960	10x1	Ø6	SI	12197	12x1	Ø6	SI	12198	16x1	Ø6	SI

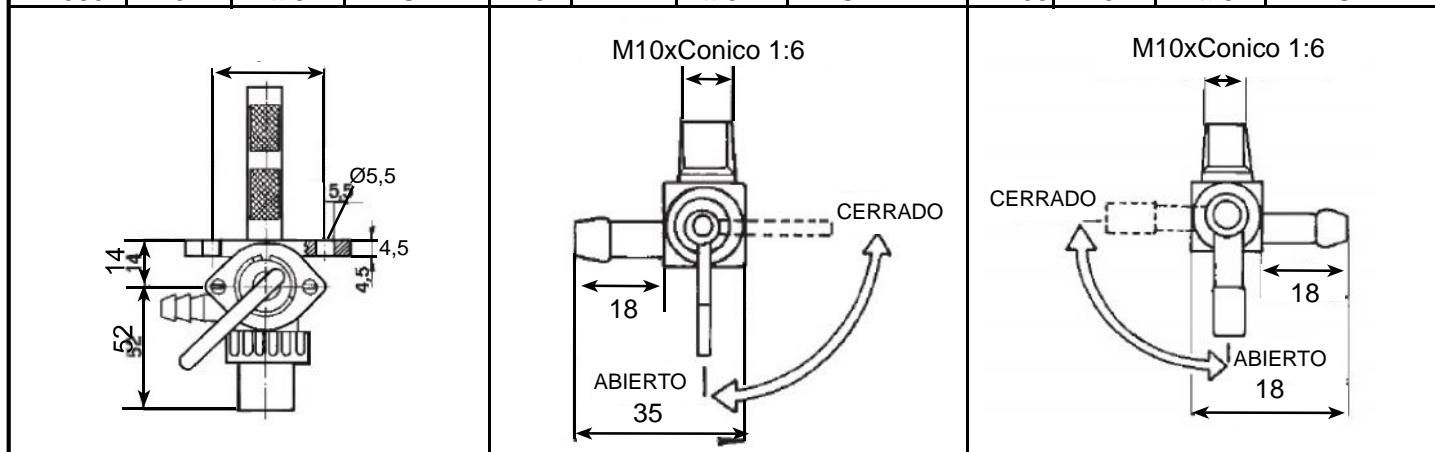

REF.	FILTRO	SALIDA	RESERVA	REF.	FILTRO	SALIDA	RESERVA	REF.	FILTRO	SALIDA	RESERVA
121990	34mm	Ø8	NO	122000	10x1 CONICO	Ø6	NO	122010	10x1 CONICO	Ø6	SI

GRIFOS COMBUSTIBLE

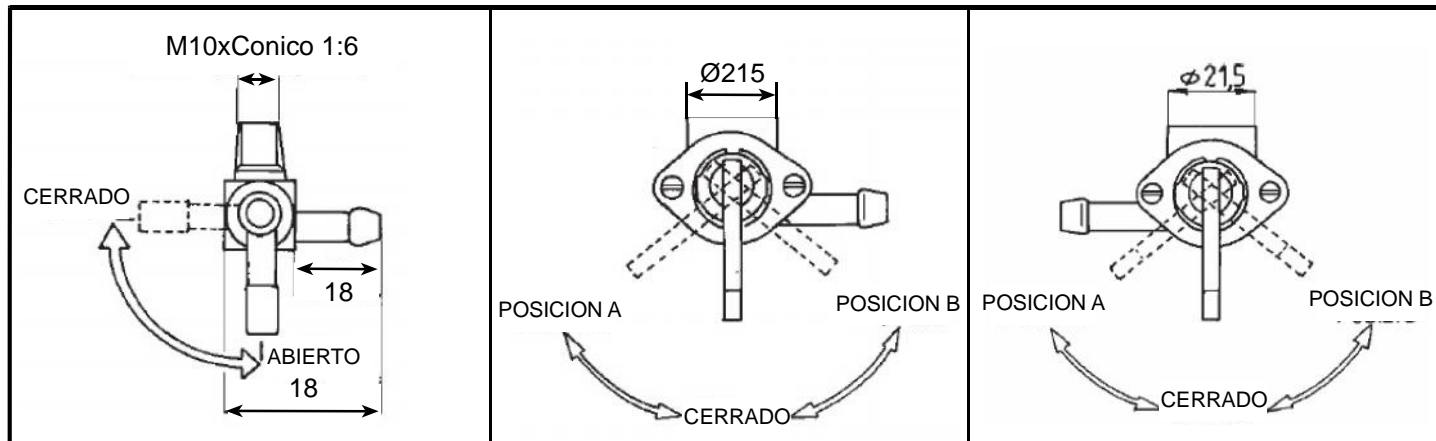

REF.	FILTRO	SALIDA	RESERVA	REF.	FILTRO	SALIDA	RESERVA	REF.	FILTRO	SALIDA	RESERVA
122020	10x1 CONICO	2 SALIDAS Ø6	SI	122030	BULON 6	Ø6	SI	122040	BULON 6	Ø6	SI

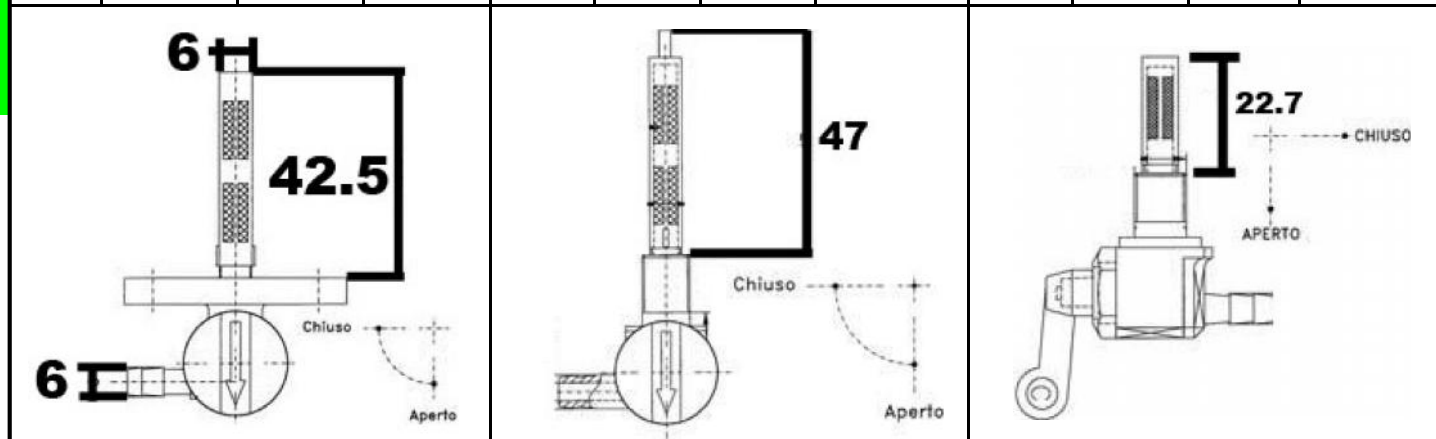

REF.	FILTRO	SALIDA	RESERVA	REF.	FILTRO	SALIDA	RESERVA	REF.	FILTRO	SALIDA	RESERVA
126330	Ø6	Ø6	-	126340	10x1	Ø7	-	126350	10x1 CONICO	Ø7	-

FILTRO DEPOSITO METALICO OHV 100-120-160-270-340-390

FILTRO DEPOSITO GASOLINA MOTOR OHV 100-120-160-270-340-390

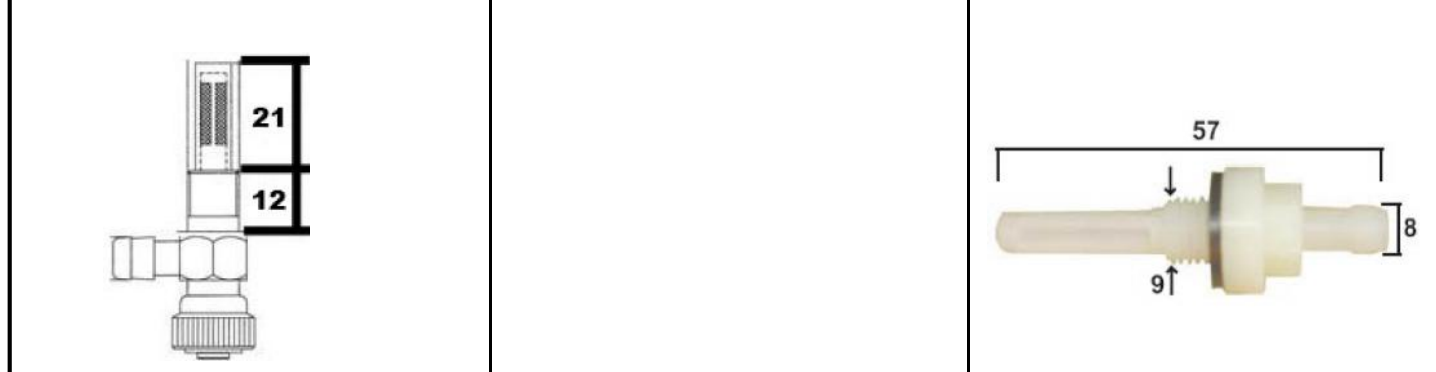

REF.	FILTRO	SALIDA	RESERVA	REF.	FILTRO	SALIDA	RESERVA	REF.	FILTRO	SALIDA	RESERVA
126360	10x1 CONICO	Ø8,4	-	78584000				78005005			

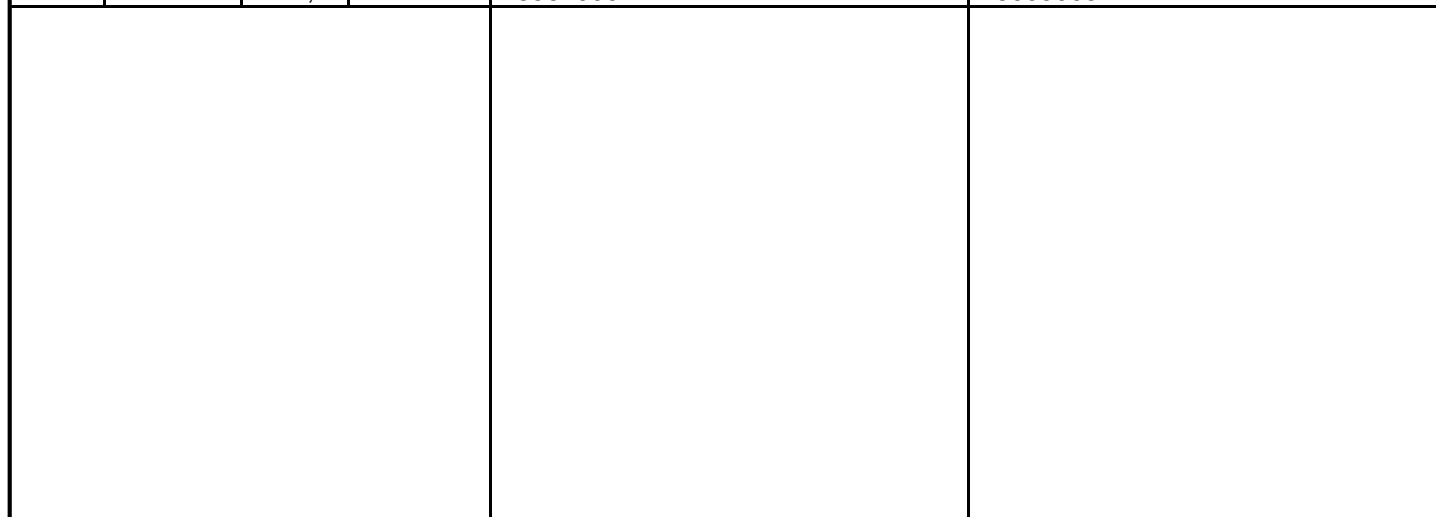

GRIFOS COMBUSTIBLE

GRIFO GEN 2500



122045

GRIFO GASOLINA UNIVERSAL



122046

GRIFO GASOLINA UNIVERSAL Ø8



122047

GRIFO GASOLINA GCV 135, 160



122048

GRIFO GASOLINA OHV 080



122049

GOMA COMBUSTIBLE





REF	DIMENSIONES	CARACTERISTICAS	DIMENSIONES
101300	Ø 5 X 9 EXT	TRANSPARENTE	10 M
10129	Ø 7 X 12 EXT	TRANSPARENTE	10 M
123260	Ø 3 X 7 EXT	GOMA NEGRA	10 M
107500	Ø 5 X 10 EXT	GOMA NEGRA	10 M
107510	Ø 6 X 11 EXT	GOMA NEGRA	10 M
107520	Ø 8 X 13 EXT	GOMA NEGRA	10 M
121850	Ø 10 X 17 EXT	GOMA NEGRA	10 M
107490	Ø 19 X 27 EXT	GOMA NEGRA	10 M
107492	Ø 19 X 27 EXT	GOMA NEGRA	5 M
107494	Ø 25 X 35 EXT	GOMA NEGRA	10 M
107496	Ø 25 X 35 EXT	GOMA NEGRA	5 M









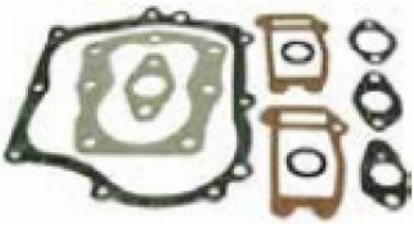

REF	DIMENSIONES	CARACTERISTICAS	DIMENSIONES
123220	Ø 2,4 X 4,8 EXT	TRANS.AMARIL.	5 M
123230	Ø 3,2X 6,4 EXT	TRANS.AMARIL.	5 M
123240	Ø 4,8X 8,0 EXT	TRANS.AMARIL.	5 M
123250	Ø 6,3 X 9,3 EXT	TRANS.AMARIL.	5 M



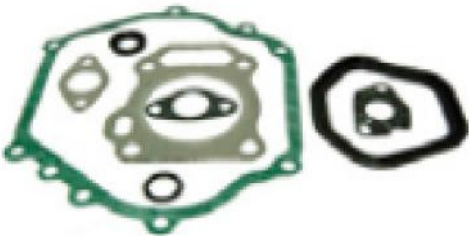
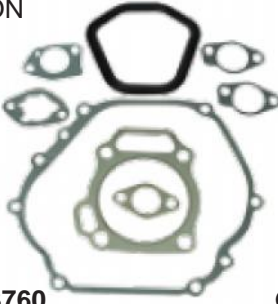





JUNTAS HONDA Y MI GARDEN

<p>KIT COMPLETO DE JUNTAS</p>  <p>78003004 78003001 78003005 78003006 78003007 78003002 78003008 78003003 78003009</p> <p>(ESPECIAL CARBON)</p>	<p>JUEGO DE JUNTAS</p>  <p>OHV 120 OHV 160 OHV 200 OHV 200 OHV 240 OHV 270 OHV 340 OHV 390 OHV420</p> <p>92152F/P1/27</p> <p>OHV152-G100</p>
--	---

HONDA

<p>JUEGO DE JUNTAS 10PCS</p>  <p>KJ018</p> <p>G150</p>	<p>JUEGO DE JUNTAS 8PCS</p>  <p>KJ020</p> <p>G300</p>	<p>JUEGO DE JUNTAS 8PCS</p>  <p>KJ021</p> <p>G400</p>
<p>JUEGO DE JUNTAS 8PCS</p>  <p>KJ022</p> <p>GX110</p>	<p>JUEGO DE JUNTAS 8PCS</p>  <p>KJ024</p> <p>GX140</p>	<p>JUEGO DE JUNTAS 8PCS</p>  <p>KJ026</p> <p>GX240</p>
<p>JUEGO DE JUNTAS ESPECIAL CARBON</p>  <p>788133760</p> <p>GX 390</p>	<p>JUEGO DE JUNTAS 11PCS</p>  <p>KJ023</p> <p>GXV120</p>	<p>JUEGO DE JUNTAS 9PCS</p>  <p>KJ027</p> <p>GXV270</p>
<p>JUEGO DE JUNTAS 8PCS</p>  <p>KJ028</p> <p>GXV340</p>	<p>JUEGO DE JUNTAS 8PCS</p>  <p>KJ029</p> <p>GXV390</p>	

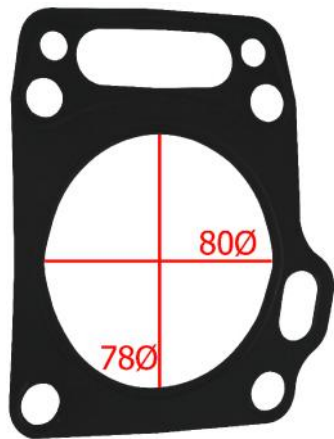
JUNTAS HONDA Y MI GARDEN

<p>JUNTA TAPA MOTOR</p>  <p>78003005 OHV80-90</p>	<p>JUNTA TAPA BALANCINES</p>  <p>78003006 OHV80-90</p>	<p>JUNTA CARCASA CULATA</p>  <p>78003007 OHV80-90</p>
<p>JUNTA CARGURADOR</p>  <p>78003014 OHV80-90</p>	<p>JUNTA CARCASA CULATA</p>  <p>78003013 H100</p>	<p>JUNTA CARCASA CULATA</p>  <p>78003012 H100</p>
<p>JUNTA CARTER OHV 620</p>  <p>78003009</p>	<p>JUNTA CULATA OHV 620</p>  <p>78003010</p>	<p>JUNTA TAPA BALANCINES</p>  <p>78003011 OHV 620</p>

JUNTAS HONDA Y MI GARDEN

JUNTA CARBON GROSOR 1,3mm



78455000

OHV120

JUNTA CULATA GROSOR 1,3mm

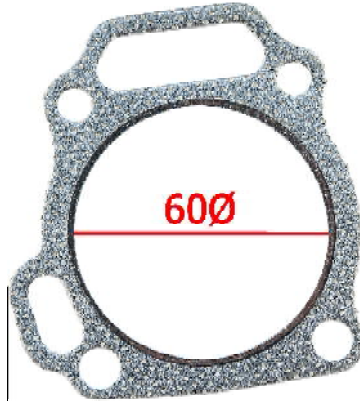

78155000

OHV120

JUNTA CULATA CARBON GROSOR 1,3mm

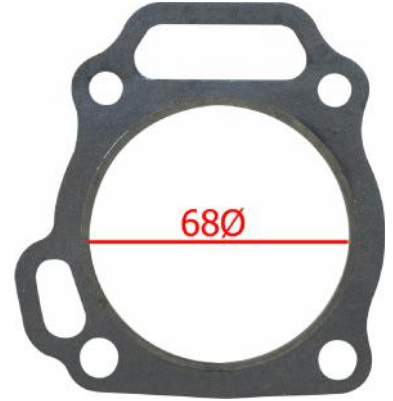

78555000

OHV160

JUNTA CULATA GROSOR



78045000

OHV160

JUNTA CULATA GROSOR

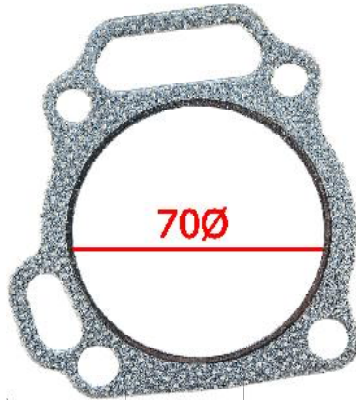

78255000

OHV200

JUNTA CULATA GROSOR

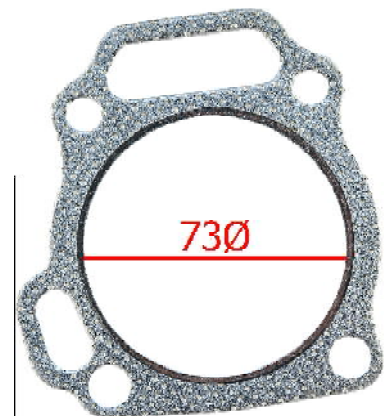

78355000

OHV240

JUNTA CULATA CARBON GROSOR 1,3mm



78965000

OHV270

JUNTA CULATA GROSOR 1,3mm

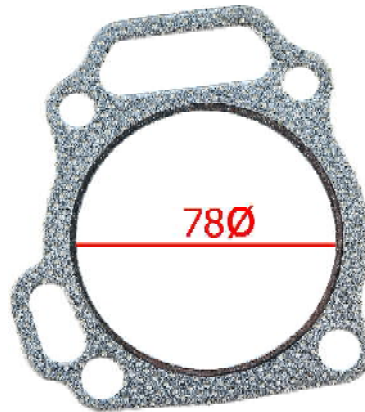

78145000

OHV270

JUNTA CULATA GROSOR 1,6mm

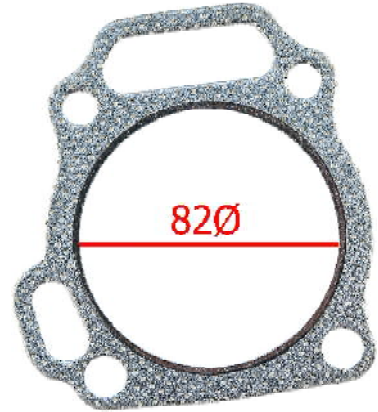

78655000

OHV340

JUNTA CULATA CARBON GROSOR 1,3mm



78175000

OHV390

JUNTA CULATA GROSOR 1,6mm

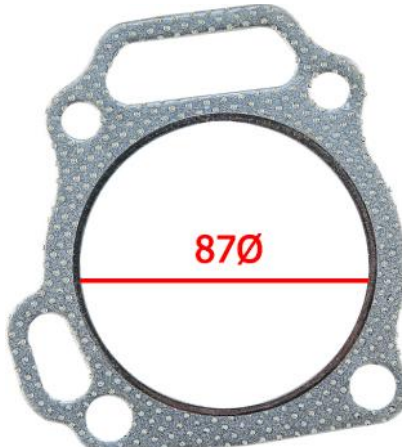

78755000

OHV390

PISTON Y SEGMENTOS ADAP. HONDA, OHV

KIT PISTON, SEGMENTOS Y BULON



MEDIDA ESTANDAR

SOBREMEDIDA 0.25

SOBREMEDIDA 0.50

REF	MODELO	REF	MODELO	REF	MODELO
78012000	OHV 80-90	78012501	H100-152	78015007	OHV 120
78012010	H100-152	78012507	OHV 120	78015008	OHV 160
78012011	OHV 110	78012502	OHV 140	78015009	OHV 200
78012012	OHV 120	78012508	OHV 160	78015010	OHV 240
78012013	OHV 140	78012503	OHV 200	78015004	OHV 270
78012001	OHV 160	78012509	OHV 240	78015005	OHV 340
78012016	OHV 160 VERTICAL	78012504	OHV 270	78015006	OHV 390
78012009	OHV 200	78012505	OHV 340		
78012014	OHV 240	78012506	OHV 390		
78012002	OHV 270				
78012015	OHV 340				
78012003	OHV 390				

PISTON HONDA GX-620 (SIN SEGMENTOS,SIN BULON)



78012004

GX, OHV 620(SIN SEGMENTOS)

PISTON HONDA GX-100 (SIN SEGMENTOS,SIN BULON)



78012005

PISTON HONDA G150 (64mm)



78012008

JUEGO SEGMENTOS STANDAR



78013000
78013001
78013002
78013003
78013004
78013005

GX, OHV 80-90
 GX, OHV 160
 GX, OHV 270
 GX, OHV 390
 GX, OHV 620
 GX 100

PISTON Y SEGMENTOS ADAP. HUSQVARNA

PARA 136,137,36 (D38)



79060102

PARA 45,245 (D42)



79060202

PARA 45 (D45)



79060402

PARA 55 (D46)



79060802

PARA 161 (D48)



79061002

PARA 141 (D40)



79061202

PARA 340 (D40)



79061402

PARA 350 (D44)



79061602

PISTON Y SEGMENTOS ADAP. MIGARDEN

PISTON Y SEGMENTO 25 cc



040325178

PARA MOTOSIERRAS DE 45cc.
CON BULON DE Ø10mm, PISTON Ø43mm, ALTO DE 38mm,



040345013334

PISTON Y SEGMENTO 2DES BROZADORA



40852014548

PISTON Y SEGMENTOS ADAP. STIHL

PARA 023 (D40)



79200802

PARA 026 (D44)



79201002

PARA 028 (D44)



79201202

PARA 044 (D50)



79201602

PARA 046 (D52)



79201802

PISTON Y SEGMENTOS ADAP. STHIL

PARA FS-2000,FS-220, (D38)



79202602

PARA FS-2000,FS-350,FS-400,FS-450,FS-480 (D44)



79202802

PARA FS-2000,FS-550 (D46)



79203002

POLEAS

POLEA EJE MOTOR

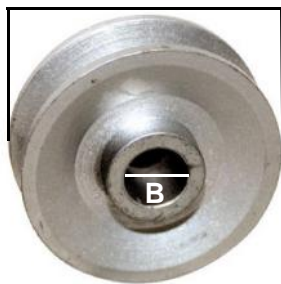

REF.	A	B	CANAL
78000109	80	CONICO 12-18	7
78000110	140	19 ESTRIAS Ø15- Ø13	7

POLEA 1 CANAL EX. Ø 60
EJE Ø 15

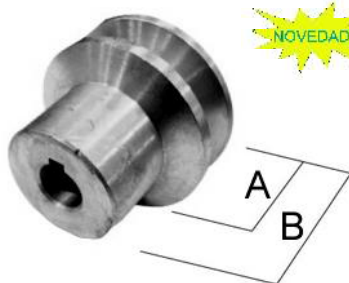

78000101

A= 51. B= 25mm

POLEA CAJA ENGRANAJES 1WG2 CANAL 4MM



78000111

POLEA 2 CANALES

POLEA SALIDA CIGÜENAL 1WG2
CANAL 4mm



78000112

POLEA 2 CANALES
A= 62. B= 44mm



78000106
78000107

EX Ø 80 EJE Ø 20
EX Ø 80 EJE Ø 28

POLEA 2 CANALES

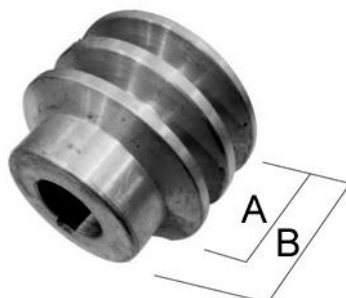

78000102 A35 B55 EX Ø 60 EJE Ø 18
78000103 A35 B55 EX Ø 60 EJE Ø 19
78000115 EX Ø 60 EJE Ø 26

POLEA 2 CANALES
A= 41. B= 90mm



78000108

EX Ø 80 EJE Ø 00

POLEA 2 CANALES

78000114

ADAPTADOR T.D.F. A INT 20mm



30481

REGULADOR DE TENSION AVR GENERADOR

AVR RECTANGULAR GEN 2500. 250V 220mF.

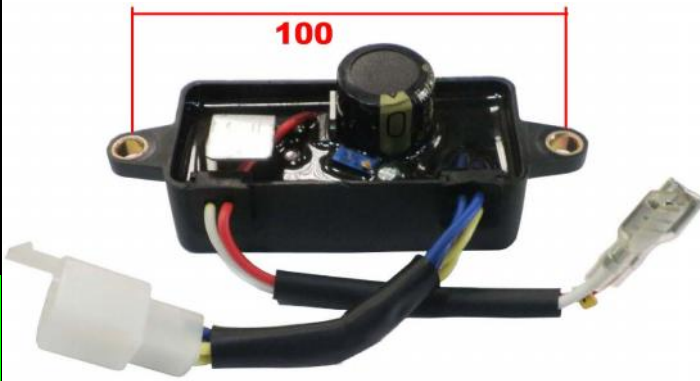

78007020

AVR MEDIA LUNA PLASTICO GEN 2500. 250V 220mF.



78007022

AVR MEDIA LUNA ALUMINIO GEN 2500. 250V 220mF.

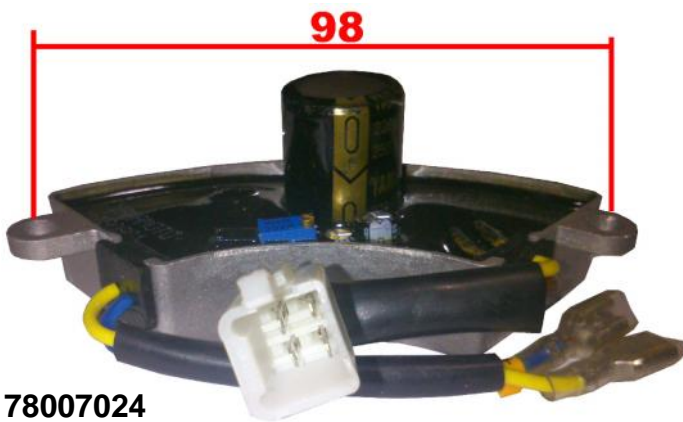

78007024

AVR MEDIA LUNA GEN 6500. 250V 470mF.



78007026

AVR MEDIA LUNA GEN 6500. 250V 470mF.



78007028

AVR GEN-6500 TRIFASICO 400V 470 MF.



78007030

AVR GEN-9500T.



78007032

RETENES

RETEN DE VALVULAS



78026011
78026012
78026013

OHV160
OHV270
OHV390

RETEN ACEITE OHV 80-90 17x30x6



17X30X6

RETEN CIGÜEÑAL



REF.	MODELO	MEDIDA
78003030	OHV100-152	17x30x6
78003031	OHV110-120	22x35x7
78003032	OHV110-120	22x41.25x7
78003033	OHV140-200	25x41.25x6
78003036	OHV140-200	25x41.25x7
78003034	OHV240-270	30x46x8
78003035	OHV340-390	35x52x8

RETEN CIGUEÑAL MOTOAZADA 25x41,25x65 (NOUKI)

25x4125x65

TAPONES

<p>TAPON NIVEL ACEITE</p>  <p>78015000 ROSCA Ø21 OHV80/90 78015001 ROSCA Ø19 OHV120-160-270-390</p>	<p>TAPON NIVEL MOTOR REDUCTOR</p>  <p>188200002SR</p>	<p>TAPON ACEITE CORTACESPED</p>  <p>78100000</p>
<p>TAPON NIVEL ACEITE</p>  <p>78015002 ROSCA Ø27</p>	<p>TAPON DEPOSITO ACEITE OHV 152</p>  <p>78015003</p>	<p>TAPON DEPOSITO ACEITE MOTOSIERRA 72 CC</p>  <p>0403720-9</p>
<p>TAPON DEPOSITO ACEITE MOTOSIERRA 25CC</p>  <p>040325180</p>	<p>TAPON DEPOSITO ACEITE MOTOSIERRA 45CC</p>  <p>0403450428</p>	<p>TAPON DEPOSITO GASOLINA MTS-18</p>  <p>508183-4-18</p>
<p>TAPON COMBUSTIBLE METALICO GENERADORES</p>  <p>78006003</p>	<p>TAPON COMBUSTIBLE METALICO OHV 120-140-160-200-240-270-340-390</p>  <p>78006011</p>	<p>TAPON COMBUSTIBLE PLASTICO OHV 120-140-160-200-240-270-340-390</p>  <p>78006001</p>

RECAMBIOS WACKER

FUELLE BS-60



78004020

CARBURADOR WACKER
BS-60 BS-70



78008039

PALANCA MANDOS BS-60



78023015

SILENBLOCK BS-60



78004025

KIT DE JUNTAS BS-60



78003025

BOBINA WACKER BS-60



78017090

TAPON GASOLINA BS-60



78015020

FILTRO GASOLINA BS-60



78005030

PORTA MANGUERAS

AUTOMATICO DE AGUA 30 MTS (28-2) Y 22 MTS(20-2) 6 BAR



5069GS045
5069GS200

28m
22m



041PP17

PORTAMANGUERA PARA PARED



041PP22

PORTAMANGUERA CON REGADERA



041PR125-9

PORTAMANGUERA PORTATIL



041PC32

MUEBLE DECORATIVO PARA MANGUERA



041PC18M

CARRO PARA FRUTA

CARRO PORTA CAJONES DE PASTICO, PARA LA FRUTA.

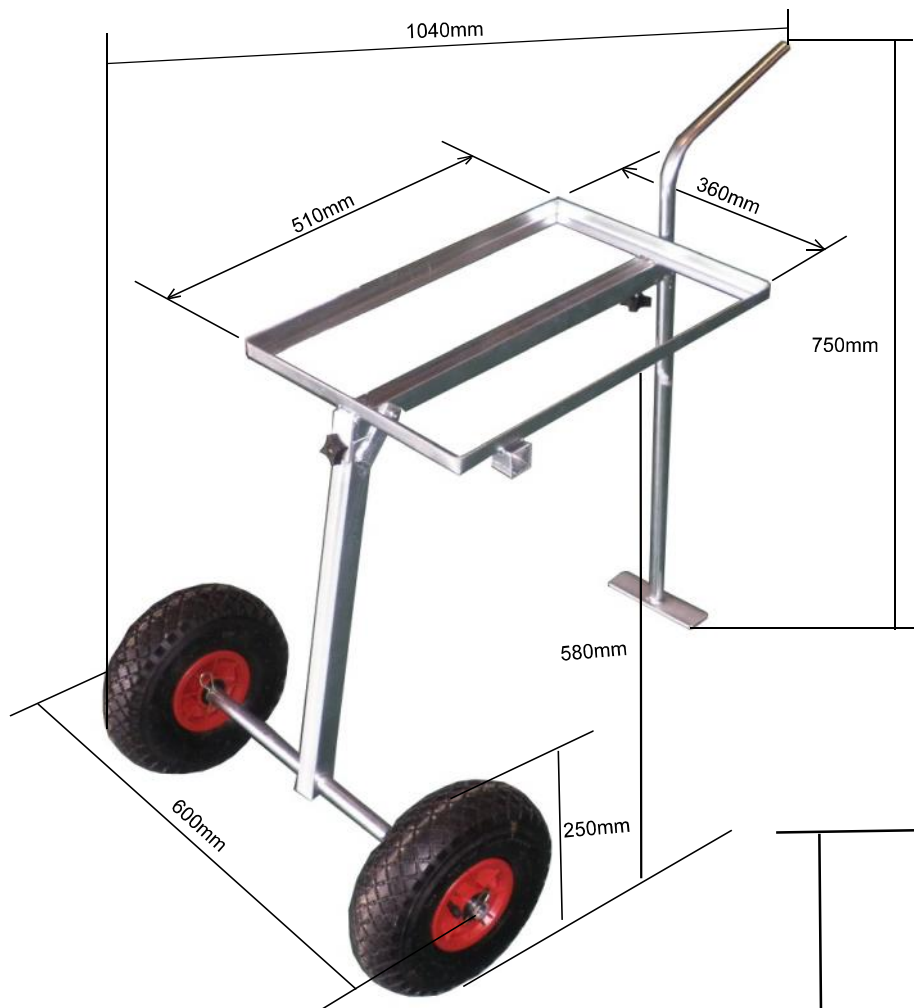

PLEGADO



267730

267731

RUEDA IMPINCHABLE

EXPOSITORES

EXPOSITOR PARED

1800mm

23ESTPM
23ESTPA

EXP. 2 PATAS
EXP. 1 PATA



EXPOSITOR GÓNDOLA

1800mm

23ESTGM
23ESTGA

EXP. 2 PATAS
EXP. 1 PATA

